

# GYNEX®

10 NEW  
PRODUCTS



CERAMIX™

**Probably** the world's  
finest biopsy punch

see page 6

*Spring 2025*

**QUALITY**

## Trevor says . . .



With spring in full bloom, we are happy to introduce the latest edition of our catalogue, a thoughtfully curated selection of medical instruments and supplies tailored to support women's healthcare.

This edition features several new products, including Metzenbaum Scissors with tungsten carbide blades, offering razor-sharp edges and increased durability, and Bozeman Uterine Forceps, especially useful for D&C procedures and IUD removal. We're also excited to introduce the Stainless Steel 4-Way Expander Speculum, designed to control side wall collapse without the need for additional instruments.

We are particularly thrilled to introduce the latest edition of a customer favorite: the Sullivan Ring Handle Biopsy Punch, now available with a Titanium coating for enhanced durability and corrosion resistance. Created by our founder, Stephen J. Sullivan, the Sullivan Biopsy Punch features a miniature bite size ideal for stenotic cervixes and minimizing unnecessary trauma.

From innovative medical instruments to quality, time-tested essentials, our goal remains the same: to support healthcare professionals with tools that uphold the highest standards of quality and performance.

Thank you for choosing Gynex as your partner in women's health. We are honored to serve you and look forward to being part of your continued success.

Sincerely,

*Trevor*

**Trevor Kurz**

Chief Operating Officer, GYNEX® Corporation

**Stephen J. Sullivan**

President and CEO, GYNEX® Corporation

1996 – 1999	International Medical Consultant
1993 – 1995	President, CooperSurgical® International Division
1991 – 1993	President, Euro-Med™ Division of CooperSurgical®
1978 – 1991	Founder and President of Euro-Med®, Inc.

VETERAN OWNED AND OPERATED SINCE 1997



# Table of Contents

Bozeman Uterine Forceps .....	2	<b>COLPOSCOPES</b> - Galileo® .....	46-51
4-Way Expander Vaginal Speculum .....	2	Accessories for Galileo® Colposcope .....	52
Metzenbaum TC Scissors .....	3	Galileo® Biological Microscope .....	53
Patel™, Multi-Use Forceps .....	4	<b>COLPOSCOPES</b> - CO Series .....	54-59
Monsef's Ferric Subsulfate Paste .....	5	Galileo® Medical Exam Light .....	60-61
Acetic Acid .....	5	Accessories for Galileo® Medical Exam Light .....	60
<b>BIOPSY PUNCHES</b> .....	6-14	Touch-Guard® Single-Use Protective Sheath .....	61
Ceramix™ Biopsy Punch .....	6	<b>HYSTERECTOMY CLAMPS</b> - Zephyr™ Titanium Rainbow™ .....	62
Opal Rainbow™ Biopsy Punch, Titanium .....	7	<b>HYSTERECTOMY SCISSORS</b> - Titanium Rainbow™ / Zephyr™ .....	63
Amethyst Biopsy Punch, Titanium .....	8	<b>NEEDLE HOLDERS</b> - Webster / Mayo Hegar / Crile Wood .....	64
Sapphire Biopsy Punch, Titanium .....	8	Laminaria Insertion Forceps .....	64
Gold Biopsy Punch, Titanium .....	9	Electrode Extender / Electrode Handpieces .....	65
Rose Gold Biopsy Punch, Titanium .....	9	<b>LLETZ ELECTRODES</b> .....	66-68
Tischler Biopsy Punch, Stainless .....	10-11	Electrosurgery Patient Dispersive Pads for LLETZ Procedure .....	69
Rotating Biopsy Punches, Stainless - ROTO Tip™ .....	12-13	Bozeman Uterine Forceps .....	70
Ring Handle Biopsy Punches, Stainless .....	14	Extended Needle Adapter and Accessories .....	71
Other Biopsy Punches, Stainless .....	14	Smoke Evacuation Systems (Pre-filter, Reducer, and Filter) .....	72
<b>TENACULUMS</b> .....	15-16	Tubing and Connectors for LLETZ Procedure .....	73
Tissue Forceps, 1x2 teeth .....	16	Sponge Forceps, Single-Use ☒ .....	74
<b>HOOKS</b> .....	17	Topical Anesthetic - HurriCaine® .....	74
<b>ENDOMETRIAL CURETTES</b> .....	17	<b>LLETZ COATED INSTRUMENTS</b>	
<b>ENDOCERVICAL CURETTES</b> .....	18	Tenaculum .....	75
Lickrish Spiral Curettes .....	19	Hooks .....	75
RotoCurette™ .....	19	Forceps .....	75
<b>ENDOCERVICAL SPECULUM</b> .....	19	Rulers .....	75
<b>FOERSTER FORCEPS</b> .....	19	4- Way Expander Vaginal Speculum .....	76
<b>OVUM FORCEPS</b> .....	20-21	Lateral Vaginal Retractor .....	77
Word Bartholin Catheter Kit .....	22	Open-Sided Speculum .....	77
Carson Myoma Polyp Grasping Forceps .....	22	Sullivan Vaginal Speculum .....	78-79
<b>KEYES PUNCHES</b> .....	23	Pederson & Graves Vaginal Speculum .....	80-81
Patel™, Multi-Use Forceps .....	24	<b>SPECULUM, STAINLESS STEEL</b>	
<b>IUD SECTION</b>		Pederson & Graves Speculum .....	82-83
CERAMIX™ Coated IUD String Scissors .....	25	Sullivan Speculum .....	84-85
IUD String Scissors .....	25	Lateral Vaginal Retractors .....	86
Villa™ Hormonal Dissecting Forceps .....	26	Auvard Weighted Speculum .....	86
Villa™ Hormonal Implant Remover .....	27	Guttman Speculum .....	87
IUD String Scissors, Single-Use .....	28	Greeberg Hysteroscopy Speculum .....	87
Alligator Grasper by GYNEX® .....	28	Open-Sided Speculum .....	88
Serpentine Grasper .....	28	Titanium Rainbow™ Speculum .....	89
IUD Removers .....	29	Fetal Doppler / Doppler Gel / Thermasonic Gel Warmer .....	90
Ascona® IUD Snare .....	30	pHem-Alert® Vaginal pH test .....	91
IUD Insertion Kit - GYNEX®, Single-Use ☒ .....	30	<b>Instrument Care and Cleaning</b>	
<b>UTERINE SOUNDS</b>		Hot Glass Beads Sterilizer - Touch-Guard® .....	92
Accu-Sound® .....	31	Low Suds Detergent Concentrate - Touch-Guard® .....	92
Sims Sound • flex .....	32	Stain Ex™ Stain Remover - Touch-Guard® .....	92
Other Sims Sound .....	32	Instrument Lubricant - Touch-Guard® .....	93
<b>UTERINE DILATORS</b> - Stainless Steel, Soft and Dennis .....	33-39	Instrument Repair and Sharpening .....	93
<b>UTERINE CURETTES</b> - Sims / Bumm .....	40	INDEX .....	95
Uterine Manipulator / Injector - Century UMI™ .....	41	ORDER INFORMATION .....	96-97
Endometrial Curette - SURESAMPLE® Select1 .....	42-43	ORDER FORM .....	97
Endometrial Sampler - SURESAMPLE® .....	44-45		

## Bozeman Uterine Forceps

Designed with long, curved jaws for optimal reach and control, Bozeman Uterine Forceps are ideal for a variety of gynecological tasks.

**New**

To learn more,  
see **page 70**

### The perfect tool for various situations!

- Holding gauze and sponges
- Grasping and handling tissues
- Removing foreign bodies or placental fragments
- Assisting in IUD removal
- Holding sutures or tissues for better access and precision

**REF 3612** 26cm Length..... **\$84<sup>95</sup>**

*Finely serrated tips to decrease trauma  
while providing a firm grip!*

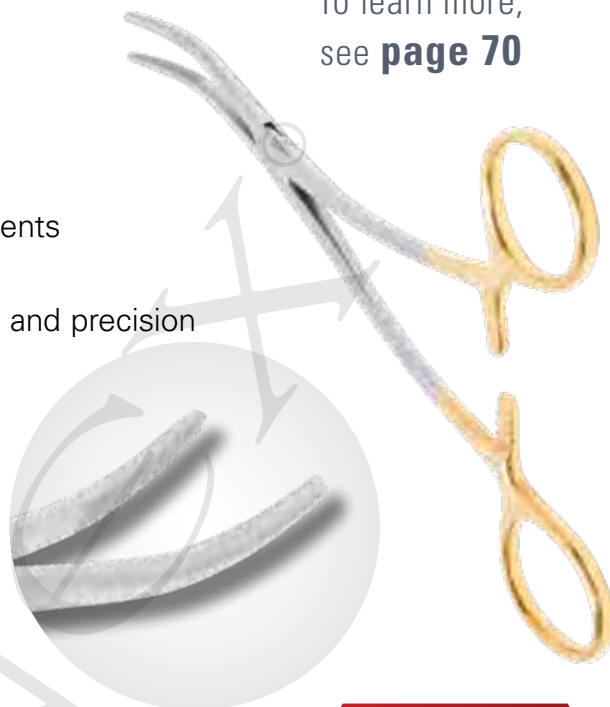

**New**

## 4-Way Expander Vaginal Speculum

The 4-Way Expander Vaginal Speculum provides a superior view with one instrument as compared to a standard speculum and lateral retractor. The built-in side blades are erected to enhance the view of the cervix as needed.

LARGE

**REF S4LEX** 125mm ..... **\$114<sup>95</sup>**

MEDIUM

**REF S4MEX** 115mm ..... **\$109<sup>95</sup>**

### Features

- Built-in lateral retractor blades
- Side blades lock firmly into place
- Pederson size blades



## Metzenbaum TC Scissors

**New**

Metzenbaum TC (*Tungsten Carbide*) Scissors are precision instruments designed for cutting delicate tissue with control and minimal trauma. Featuring tungsten carbide inserts for long-lasting sharpness and durability, these scissors offer superior cutting performance and reliability.

<b>REF</b> <b>MSTC14C</b>	14cm Length, <i>Curved</i> .....	<b>\$89<sup>95</sup></b>
<b>REF</b> <b>MSTC14S</b>	14cm Length, <i>Straight</i> .....	<b>\$89<sup>95</sup></b>
<b>REF</b> <b>MSTC18C</b>	18cm Length, <i>Curved</i> .....	<b>\$89<sup>95</sup></b>
<b>REF</b> <b>MSTC18S</b>	18cm Length, <i>Straight</i> .....	<b>\$89<sup>95</sup></b>



*The fine, tapered blades and lightweight design make them ideal for soft tissue dissection in a variety of surgical procedures.*

# Patel™

## Multi-Use Forceps

*New*

The one instrument that every gynecologist needs in their practice. With its patent-pending design, the **Patel™** excels at multiple functions:

- IUD Remover
- Sponge / Foerster Forceps
- Needle Holder
- Atraumatic Tissue Grasper
- *More!*

REF NHL3450 ..... **\$119<sup>95</sup>**

**The Patel is the  
*Swiss Army Knife*  
of Gynecology**

To learn more,  
see **page 24**



# Monse's Ferric Subsulfate Paste 20-22%

Monse's is a pre-thickened formulation of the popular hemostatic agent. Apply directly to the surgical site following excision of tissue.

- Box of 12 Individual - 8ml vials
- 12 rayon-tipped applicator swabs
- Single-Patient-Use 

**REF 5055** Box of 12 ..... **\$205<sup>95</sup>**

Controls bleeding after biopsy, LLETZ and laser procedures.



# Acetic Acid 5%

- Box of 12 Individual - 12ml vials
- 12 rayon-tipped applicator swabs
- Single-Patient-Use 

**REF AA312** Box of 12 ..... **\$94<sup>95</sup>**

Helps enhance the appearance of abnormal areas.



# CERAMIX™ Biopsy Punches



Our sharpest, longest lasting biopsy punch

CERAMIX™ coated biopsy punches offer increased resistance to corrosion and resilience against impact and low friction coefficient results on the market. Sharper up to 10 times longer than ordinary stainless steel with incomparable cutting-edge hardness.

See Hardness Comparison Chart below.

## Hardness Comparison Chart

METAL	(HV 0.05)	COATED METAL	(HV 0.05)
Stainless Steel	550	Titanium Nitride	2900
Tungsten Carbide	650	CERAMIX Coating	4500

Vickers Hardness Test - HV/0.05 meaning a 50g load was used.



GYNEX®  
**Original!**



### CERAMIX™ Mini-Tischler

**Actual Bite Size:**

4.2mm x 2.3mm

REF 1060

20cm Shaft ..... **\$537<sup>95</sup>**



### CERAMIX™ Medium Tischler

**Actual Bite Size:**

5mm x 3mm

REF 1065

20cm Shaft ..... **\$537<sup>95</sup>**



### CERAMIX™ Tischler

**Actual Bite Size:**

7mm x 3mm

REF 1070

20cm Shaft ..... **\$537<sup>95</sup>**



### CERAMIX™ Apex™

**Actual Bite Size:**

7mm x 3mm

REF 1075

20cm Shaft ..... **\$537<sup>95</sup>**



# Opal Rainbow™ Biopsy Punches, TITANIUM

Exclusive Titanium coated biopsy punches offer increased resistance to corrosion, resilience against impact and low friction coefficient. Stays sharper and smoother longer than traditional stainless steel.

- Double-spring handle



GYNEX®  
Original!

## OPAL RAINBOW™ Tischler

Actual Bite Size: 7mm x 3mm 

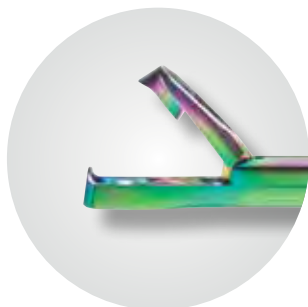

### Tischler

REF TT010 20cm Shaft .... **\$439<sup>95</sup>**

REF TT035

25cm Shaft, Extra-Long .... **\$449<sup>95</sup>**  
bariatric

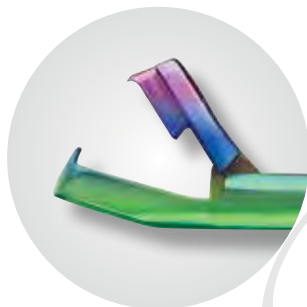

### Tischler, Tip Up

REF TT011 20cm Shaft .... **\$439<sup>95</sup>**

REF TT036

25cm Shaft, Extra-Long .... **\$449<sup>95</sup>**  
bariatric

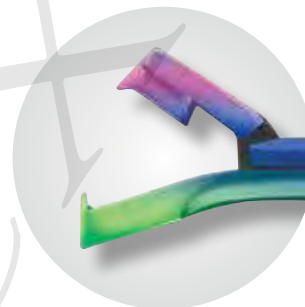

### Tischler, Tip Down

REF TT012 20cm Shaft .... **\$439<sup>95</sup>**

REF TT037

25cm Shaft, Extra-Long .... **\$449<sup>95</sup>**  
bariatric

## OPAL RAINBOW™ Mini-Tischler

Actual Bite Size: 4.2mm x 2.3mm 



### Mini-Tischler

REF TT005 20cm Shaft .... **\$439<sup>95</sup>**

REF TT030

25cm Shaft, Extra-Long .... **\$449<sup>95</sup>**  
bariatric



### Mini-Tischler, Tip Up

REF TT006 20cm Shaft .... **\$439<sup>95</sup>**

REF TT031

25cm Shaft, Extra-Long .... **\$449<sup>95</sup>**  
bariatric



### Mini-Tischler, Tip Down

REF TT007 20cm Shaft .... **\$439<sup>95</sup>**

REF TT032

25cm Shaft, Extra-Long .... **\$449<sup>95</sup>**  
bariatric

# Amethyst Biopsy Punches, TITANIUM

Designed for excellence • Manufactured for durability



## Amethyst Tischler

Actual Bite Size: 7mm x 3mm

REF TA010  
20cm Shaft ..... \$439<sup>95</sup>



## Amethyst Mini-Tischler

Actual Bite Size: 4.2mm x 2.3mm

REF TA005  
20cm Shaft ..... \$439<sup>95</sup>



GYNEX<sup>®</sup>  
Original!

# Rose Gold Biopsy Punches, TITANIUM

Designed for excellence • Manufactured for durability



## Rose Gold Tischler

Actual Bite Size: 7mm x 3mm

REF PINK010  
20cm Shaft ..... \$439<sup>95</sup>

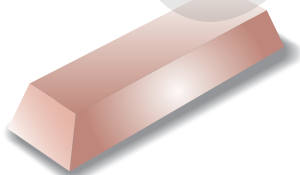

## Rose Gold Mini-Tischler

Actual Bite Size: 4.2mm x 2.3mm

REF PINK005  
20cm Shaft ..... \$439<sup>95</sup>



GYNEX<sup>®</sup>  
Original!

# Gold Biopsy Punches, TITANIUM

Designed for excellence • Manufactured for durability



## Gold Tischler

Actual Bite Size: 7mm x 3mm

REF TAU010

20cm Shaft ..... \$439<sup>95</sup>

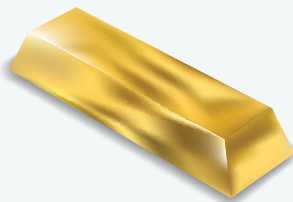

## Gold Mini-Tischler

Actual Bite Size: 4.2mm x 2.3mm

REF TAU005

20cm Shaft ..... \$439<sup>95</sup>



# Sapphire Biopsy Punches, TITANIUM

Designed for excellence • Manufactured for durability



## Sapphire Tischler

Actual Bite Size: 7mm x 3mm

REF TB010

20cm Shaft ..... \$439<sup>95</sup>



GYNEX<sup>®</sup>  
Original!

## Sapphire Mini-Tischler

Actual Bite Size: 4.2mm x 2.3mm

REF TB005

20cm Shaft ..... \$439<sup>95</sup>



# TISCHLER™

## BIOPSY PUNCH

### STAINLESS



GYNEX®  
Original!



The Best Selling Design in The World

*Invented by GYNEX President Stephen J. Sullivan,  
the modern Tischler Biopsy Punch is the  
#1 Selling Design Worldwide!*

## Tischler

Actual Bite Size: 7mm x 3mm

### Tischler

REF 1010 20cm Shaft ..... \$419<sup>95</sup>

REF 1035 25cm Shaft, Extra Long... \$427<sup>95</sup>  
bariatric



### Tischler, Tip Up

REF 1012 20cm Shaft ..... \$419<sup>95</sup>

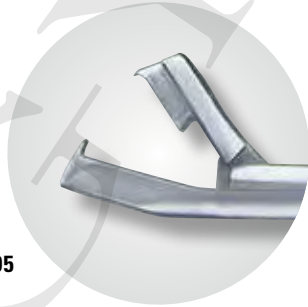

### Tischler, Tip Down

REF 1014 20cm Shaft ..... \$419<sup>95</sup>



## Mini-Tischler

Actual Bite Size: 4.2mm x 2.3mm

### Mini-Tischler

REF 1005 20cm Shaft..... \$419<sup>95</sup>

REF 1030 25cm Shaft, Extra Long... \$427<sup>95</sup>  
bariatric



### Mini-Tischler, Tip Up

REF 1006 20cm Shaft ..... \$419<sup>95</sup>



### Mini-Tischler, Tip Down

REF 1007 20cm Shaft ..... \$419<sup>95</sup>



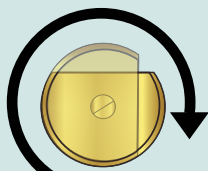

**SURE-LOCK**

Tip-Locking Thumb Tab

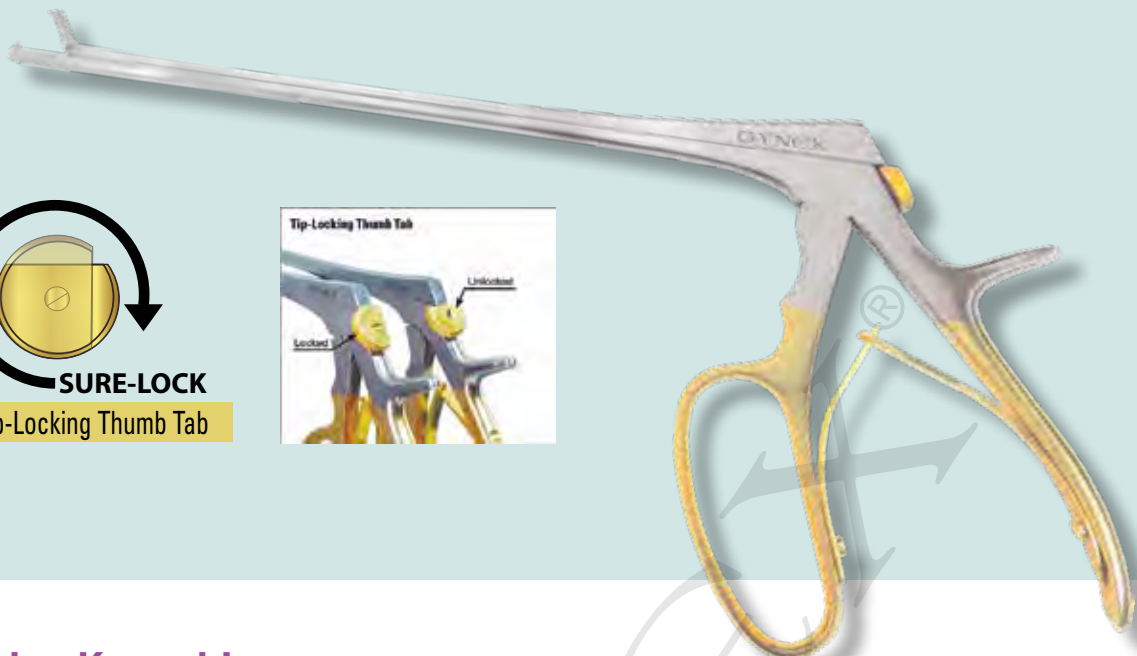

## Tischler Kevorkian

Single anchoring tooth on top and bottom jaws

Actual Bite Size: 9mm x 3mm

### Tischler-Kevorkian

REF 1015 20cm Shaft ..... \$419<sup>95</sup>

REF 1037 25cm Shaft, Extra Long..... \$427<sup>95</sup>

bariatric



## Kevorkian

- Traditional Kevorkian bite
- Four teeth on bottom jaw

Actual Bite Size: 9mm x 3mm

REF 1029 20cm Shaft ..... \$419<sup>95</sup>



## Medium Tischler

Actual Bite Size: 5mm x 3mm

### Medium Tischler

REF 1008 20cm Shaft ..... \$419<sup>95</sup>

REF 1033 25cm Shaft, Extra Long... \$427<sup>95</sup>

bariatric



5% Discount on Prepaid Orders by Check or ACH payment (offer excludes microscopes, colposcopes and/or extended warranties).

# RotoTIP™ Biopsy Punch, STAINLESS



**RotoTIP™** rotating biopsy punches offers the added convenience of changing the biopsy tip size and shape without the expense of having additional complete biopsy punches. With a single handle, you can have several tips available. Although the Standard Tip Tischler and the Mini-Tischler are the most popular, this design provides you a cost savings option to add angled tips. These tips easily rotate, allowing you to gain better positioning for a biopsy sample.

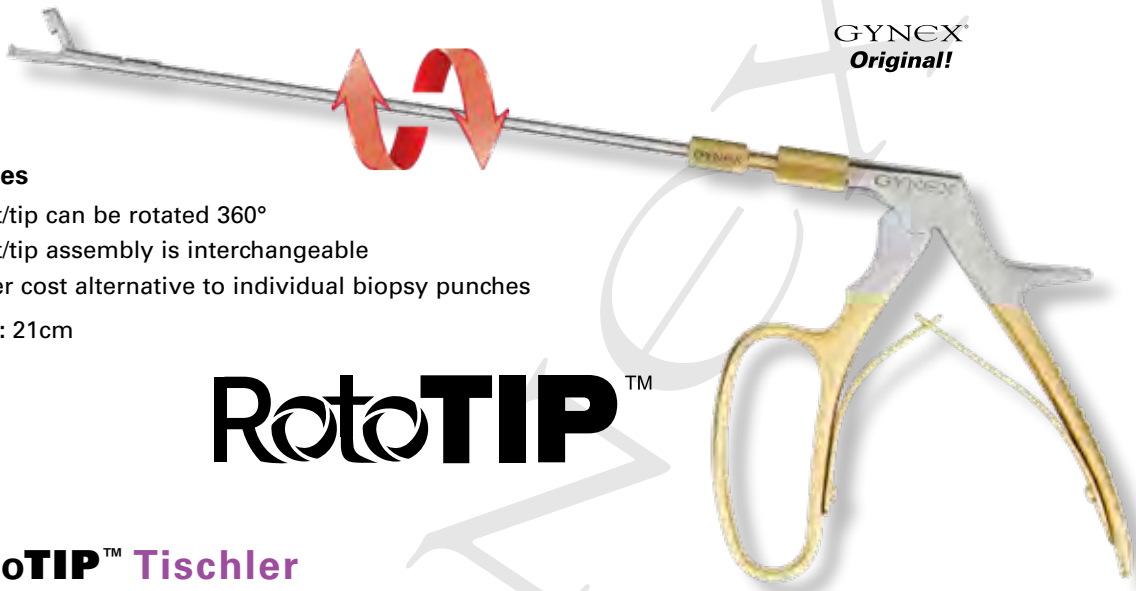

## Features

- Shaft/tip can be rotated 360°
- Shaft/tip assembly is interchangeable
- Lower cost alternative to individual biopsy punches

**Length:** 21cm

# RotoTIP™

## RotoTIP™ Tischler

Actual Bite Size: 7mm x 3mm

### Tischler

REF 1200-10  
Complete Punch ..... \$499<sup>95</sup>

REF 1210  
Tip Only ..... \$304<sup>95</sup>

### Tischler, Tip-Up

REF 1200-30  
Complete Punch ..... \$499<sup>95</sup>

REF 1230  
Tip Only ..... \$304<sup>95</sup>

### Tischler, Tip-Down

REF 1200-20  
Complete Punch ..... \$499<sup>95</sup>

REF 1220  
Tip Only ..... \$304<sup>95</sup>

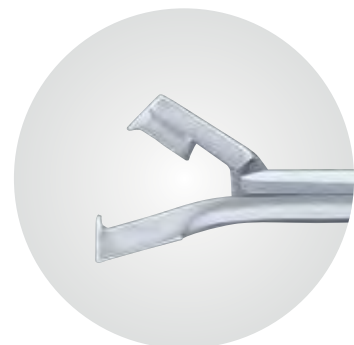

# RotoTIP™ Mini-Tischler

Actual Bite Size: 4.2mm x 2.3mm 

## Mini-Tischler

REF 1200-05  
Complete Punch ..... \$499<sup>95</sup>

REF 1205  
Tip Only ..... \$304<sup>95</sup>



## Mini-Tischler, Tip-Down

REF 1200-15  
Complete Punch ..... \$499<sup>95</sup>

REF 1215  
Tip Only ..... \$304<sup>95</sup>



## Mini-Tischler, Tip-Up

REF 1200-25  
Complete Punch ..... \$499<sup>95</sup>

REF 1225  
Tip Only ..... \$304<sup>95</sup>

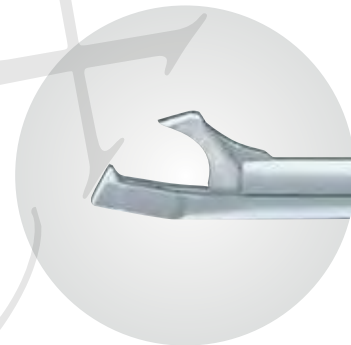

# RotoTIP™ Oval

Actual Bite Size: 5mm x 3mm 

## Oval Tip

REF 1200-35  
Complete Punch ..... \$499<sup>95</sup>

REF 1235  
Tip Only ..... \$304<sup>95</sup>



# RotoTIP™ Kevorkian

Actual Bite Size: 9mm x 3mm 

## Kevorkian Tip

REF 1200-40  
Complete Punch ..... \$499<sup>95</sup>

REF 1240  
Tip Only ..... \$304<sup>95</sup>



## RotoTIP™ Handle

REF 1200  
Handle Only ..... \$215<sup>95</sup>



# Ring Handle Biopsy Punches, STAINLESS



## Sullivan Ring Handle Punch

Excellent for stenotic cervix

- Small handle / Mini tip

Actual Bite Size: 4mm x 2mm

REF 1050

24cm Shaft ..... \$419<sup>95</sup>



## Kevorkian Ring Handle Punch

- Traditional Kevorkian bite
- Four teeth on bottom jaw

Actual Bite Size: 9mm x 3mm

REF 1053

25cm Shaft ..... \$419<sup>95</sup>



# Biopsy Punches, STAINLESS



## Apex™

V-shaped anchoring jaw on the top and bottom

Actual Bite Size: 7mm x 3mm

### Apex™

REF 1025 20cm Shaft ..... \$419<sup>95</sup>

REF 1039 25cm Shaft, Extra Long ..... \$427<sup>95</sup>

bariatric

GYNEX®  
Original!





# Tenaculums

## Braun Tenaculum

### LiteTouch™ TIP

LiteTouch tips overlap 1-2 mm ±1mm (when closed)



### Straight Handle

REF T2230 25cm Length ..... **\$59<sup>95</sup>**

### Angled Handle

REF T2235 25cm Length ..... **\$65<sup>95</sup>**

### Standard TIP

Standard tips overlap 4-6 mm ±1mm (when closed)



### Straight Handle

REF 3502 25cm Length ..... **\$59<sup>95</sup>**

REF B230 30cm Length ..... **\$67<sup>95</sup>**

### Angled Handle

REF 3532 25cm Length ..... **\$65<sup>95</sup>**

## Schroeder Tenaculum

### LiteTouch™ TIP

LiteTouch tips overlap 1-2 mm ±1mm (when closed)



### Straight Handle

REF T2222 25cm Length ..... **\$59<sup>95</sup>**

### Angled Handle

REF T2225 25cm Length ..... **\$65<sup>95</sup>**

### Standard TIP

Standard tips overlap 4-6 mm ±1mm (when closed)



### Straight Handle

REF 3500 25cm Length ..... **\$59<sup>95</sup>**

REF B130 30cm Length ..... **\$67<sup>95</sup>**

### Angled Handle

REF 3530 25cm Length ..... **\$65<sup>95</sup>**

## Double Tooth



### Straight Handle

REF 3501 Length 25cm ..... **\$65<sup>95</sup>**

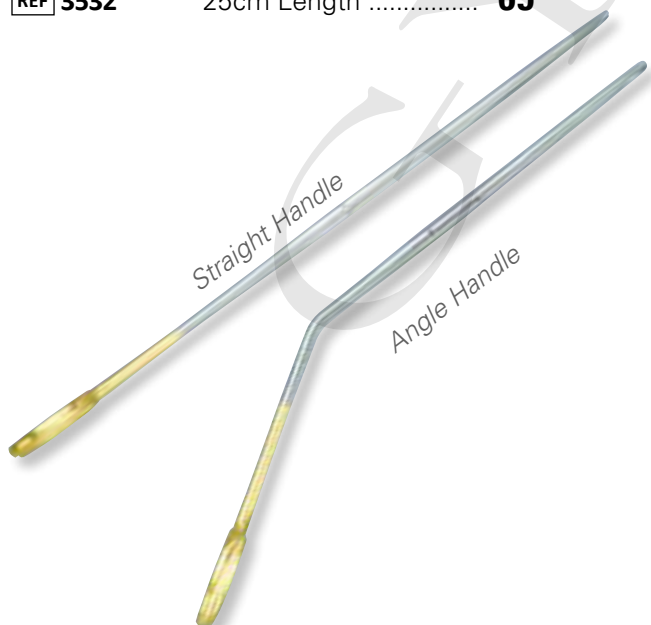

## Teale Tenaculum

*Slight Curve*

REF 3536 25cm Length ..... \$59<sup>95</sup>



## Skene Tenaculum

*Slight Curve*

REF 3534 24cm Length ..... \$59<sup>95</sup>

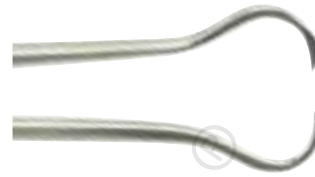

## Foerster Foceps



### Straight Handle

REF 3540 24cm Length ..... \$59<sup>95</sup>

REF B330 30cm Length ..... \$67<sup>95</sup>

### Angled Handle

REF 3542 24cm Length ..... \$67<sup>95</sup>

## Tissue Forceps

Hold and manipulate various tissue.

REF S3205 21.5cm Length ..... \$62<sup>95</sup>

REF BTF25 25cm Length ..... \$62<sup>95</sup>

REF BTF30 30cm Length ..... \$62<sup>95</sup>



## Endocervical Speculum

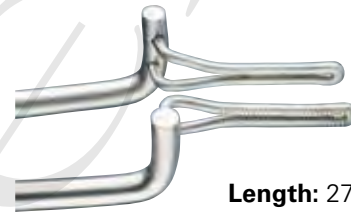

Length: 27cm

### Ratchet Handle

REF 2130 3mm Tip ..... \$197<sup>95</sup>

REF 2140 4mm Tip ..... \$197<sup>95</sup>

### No Ratchet

REF 2030 3mm Tip ..... \$187<sup>95</sup>

REF 2040 4mm Tip ..... \$187<sup>95</sup>



# Hooks

## Angle Hook

REF 3225

26cm Length .... \$49<sup>95</sup>

## Iris Hook

REF 3210

26cm Length .... \$49<sup>95</sup>

## 2-Prong Hook

REF 3227

26cm Length .... \$59<sup>95</sup>

## Emmett Tenaculum

REF 3220

26cm Length .... \$49<sup>95</sup>

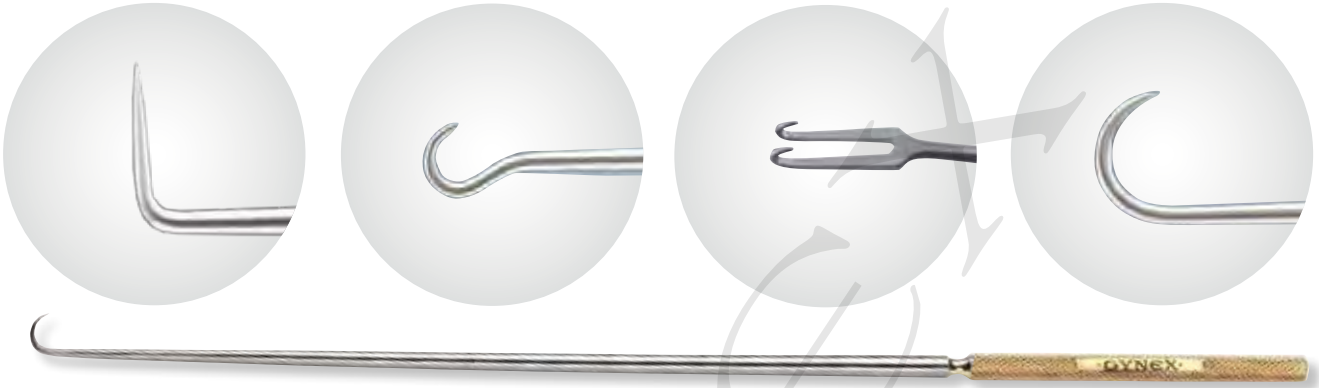

# Endometrial Curettes

## Novak Curette

- Luer lock suction attachment

Length: 25cm

Shaft/Tip Size: 2mm ●

REF 3302 ..... \$57<sup>95</sup>

Shaft/Tip Size: 3mm ●

REF 3303 ..... \$57<sup>95</sup>

Shaft/Tip Size: 4mm ●

REF 3304 ..... \$57<sup>95</sup>

## Randall Curette

- Luer lock suction attachment

Length: 25cm

Shaft/Tip Size: 2mm ●

REF 3310 ..... \$57<sup>95</sup>

Shaft/Tip Size: 3mm ●

REF 3312 ..... \$57<sup>95</sup>

Shaft/Tip Size: 4mm ●

REF 3314 ..... \$57<sup>95</sup>

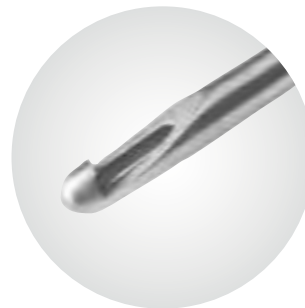

# Endocervical Curettes

## Kevorkian Curette with Basket Square Tip

Features a basket for secure sample collection during curettage procedures.

**Basket Size:** 10.5mm x 2mm

**REF** TC3005

Titanium Rainbow ... **\$86<sup>95</sup>**



**REF** 3005

Stainless Steel ..... **\$79<sup>95</sup>**



## Kevorkian Curette Square Tip

**Opening:** 12mm x 2mm

**REF** TC3010

Titanium Rainbow ... **\$86<sup>95</sup>**



**REF** 3010

Stainless Steel ..... **\$79<sup>95</sup>**



## Dublin Curette Round Tip

Provides samples when aggressive scraping is necessary for hard to sample tissue.

**Diameter:** 4mm

**REF** TC3025

Titanium Rainbow ... **\$86<sup>95</sup>**



**REF** 3025

Stainless Steel ..... **\$79<sup>95</sup>**



## Kevorkian Curette with Basket Round Tip

Features a basket for secure sample collection and a rounded tip for easier insertion.

**Basket Size:** 11.5mm x 2mm

**REF** TC3015

Titanium Rainbow ... **\$86<sup>95</sup>**



**REF** 3015

Stainless Steel ..... **\$79<sup>95</sup>**



## Townsend Curette

Designed with a small, pointed tip to facilitate easier penetration of the os.

**Opening:** 7mm x 1.3mm

**REF** TC3020

Titanium Rainbow ... **\$86<sup>95</sup>**



**REF** 3020

Stainless Steel ..... **\$79<sup>95</sup>**



## Curette Sharpening File

A compact, tapered sharpening stone with a diamond coating to maintain your curette's sharpness.

**REF** CSF3900 ..... **\$34<sup>95</sup>**

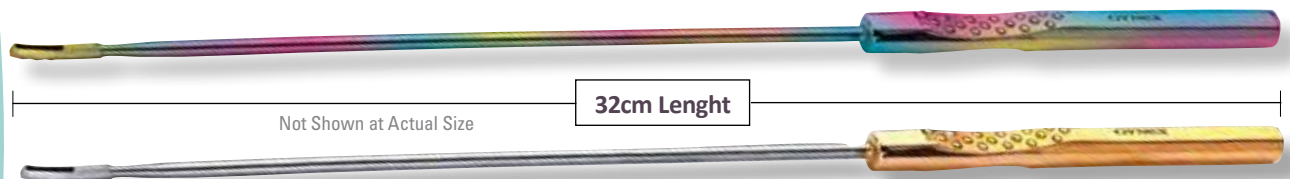

## Lickrish Spiral Curettes

### Dilator • Curette



The innovative Endocervical Lickrish Spiral Dual-Purpose Curette was developed by Dr. Gordon M Lickrish, former director of the colposcopy unit at University Health Network in Toronto. The spiral design is ideal for addressing cases of severe cervical stenosis and narrow endocervical canals, allowing for gentle insertion, dilation, and precise tissue sampling when standard curettes are inadequate. The tip can be gently guided through the Os while simultaneously advancing and rotating.

### Titanium Cobalt

REF TB3040 21cm Length ..... \$86<sup>95</sup>



### Titanium Rainbow

REF TC3040 21cm Length ..... \$86<sup>95</sup>



### Stainless Steel

REF 3040 21cm Length ..... \$82<sup>95</sup>



## RotoCurette™

The RotoCurette ECC is inserted into the canal and rotated to obtain samples from both sides.

REF 3050

Stainless Steel ..... \$82<sup>95</sup>



## Kevorkian Curette, Single-Use

Featuring a sharp basket tip and firm, angled handle for stability, leverage, and precise maneuverability during curettage procedures.

REF 3030 Box of 25 ..... \$82<sup>95</sup>

Total Length: 31cm

Inner Basket: 3mm

Working Length: 16cm

OD: 4mm

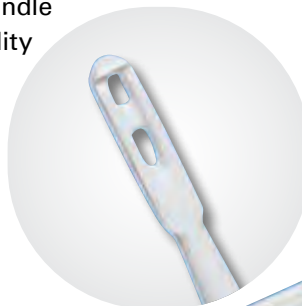

STERILE EO Single-Use

Not made with natural rubber latex.

# Ovum Forceps

## Sopher Ovum Forceps

### Sopher Original

**Length: 25.5cm (10") Curved Jaw 11mm**

REF 3544 Ratchet Handle ..... **\$114<sup>95</sup>**

REF 3546 No Ratchet ..... **\$109<sup>95</sup>**



*Sopher Original "lips" protect surrounding tissue*



Sopher Jaw  
Actual Size: 11mm

### Sopher Standard

**Length: 25.5cm (10") Curved Jaw 12mm**

REF 3548 Ratchet Handle ..... **\$114<sup>95</sup>**

REF 3550 No Ratchet ..... **\$109<sup>95</sup>**



*Sopher Original Jaw Open*



Sopher Jaw  
Actual Size: 12mm

**Length: 25.5cm (10") Curved Jaw 14mm**

REF 3552 Ratchet Handle ..... **\$119<sup>95</sup>**

REF 3554 No Ratchet ..... **\$114<sup>95</sup>**



*Sopher Standard Jaw Closed*

**Length: 28cm (11") Curved Jaw 12mm**

REF 3556 Ratchet Handle ..... **\$114<sup>95</sup>**

REF 3558 No Ratchet ..... **\$109<sup>95</sup>**

**Length 28cm (11") Curved Jaw 14mm**

REF 3560 Ratchet Handle ..... **\$119<sup>95</sup>**

REF 3562 No Ratchet ..... **\$114<sup>95</sup>**



*Sopher Standard Jaw Open*



Sopher Jaw  
Actual Size: 14mm

**Length: 33cm (13") Curved Jaw 12mm**

REF 3564 Ratchet Handle ..... **\$124<sup>95</sup>**

REF 3566 No Ratchet ..... **\$119<sup>95</sup>**

**Length: 33cm (13") Curved Jaw 14mm**

REF 3568 Ratchet Handle ..... **\$129<sup>95</sup>**

REF 3570 No Ratchet ..... **\$124<sup>95</sup>**

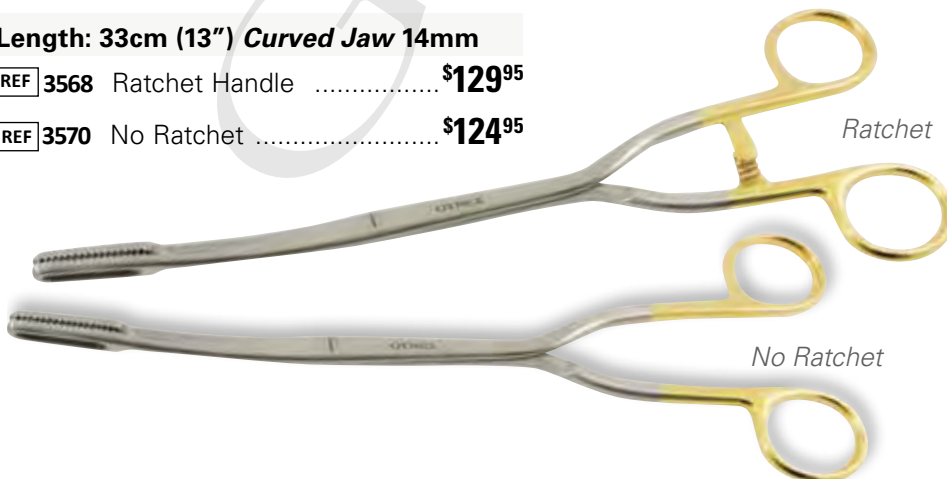

*Ratchet*

*No Ratchet*

## Bierer Ovum Forceps

**Length: 28cm (11") Straight Jaw 16mm**

REF 3572 Ratchet Handle ..... \$114<sup>95</sup>

REF 3574 No Ratchet ..... \$109<sup>95</sup>

**Length: 28cm (11") Straight Jaw 19mm**

REF 3576 Ratchet Handle ..... \$119<sup>95</sup>

REF 3578 No Ratchet ..... \$114<sup>95</sup>

**Length: 33cm (13") Straight Jaw 16mm**

REF 3580 Ratchet Handle ..... \$119<sup>95</sup>

REF 3582 No Ratchet ..... \$114<sup>95</sup>

**Length: 33cm (13") Straight Jaw 19mm**

REF 3584 Ratchet Handle ..... \$124<sup>95</sup>

REF 3586 No Ratchet ..... \$119<sup>95</sup>



*Bierer, Jaw Open*

## Jacobson Ovum Forceps

**Length: 28cm (11") Straight Jaw 20mm**

REF 3588 No Ratchet ..... \$114<sup>95</sup>

**Length: 33cm (13") Straight Jaw 20mm**

REF 3590 No Ratchet ..... \$114<sup>95</sup>

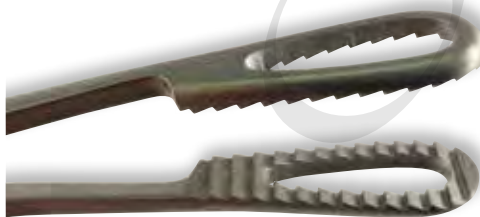

*Jacobson, Jaw Open*

## Blumenthal Ovum Forceps

**Length: 28cm (11") Straight Jaw 20mm**

REF 3592 No Ratchet ..... \$114<sup>95</sup>

**Length: 33cm (13") Straight Jaw 20mm**

REF 3594 No Ratchet ..... \$119<sup>95</sup>



*Blumenthal  
"lips" protect surrounding tissue*

## Saenger Ovum Forceps

**Length: 26.5cm (10.5") Straight Jaw 16mm**

REF 3596 Ratchet Handle ..... \$114<sup>95</sup>

REF 3598 No Ratchet ..... \$109<sup>95</sup>

**Length: 26.5cm (10.5") Curved Jaw 16mm**

REF 3600 Ratchet Handle ..... \$114<sup>95</sup>

REF 3602 No Ratchet ..... \$109<sup>95</sup>



*Saenger Inner diameter teeth within oval jaws*



*Blumenthal*

## Word Bartholin Catheter Kit

STERILE EO Single-Use

Not made with natural rubber latex.

The Word Bartholin Catheter Kit contains everything you need for an effective office treatment of Bartholin gland abscesses and cysts providing patients with immediate relief.

### Each Kit Contains:

- (1) Silicone inflatable catheter
- (1) Scalpel
- (1) 3cc Syringe w/24 GA Needle

REF 10-200 Box of 2 kits ..... \$67<sup>95</sup>

*Outpatient Treatment for Bartholin gland cysts and abscesses.*

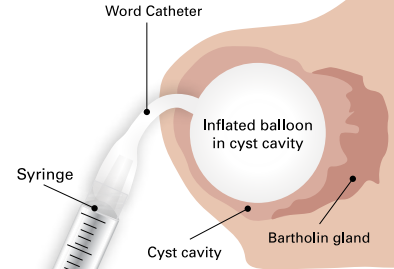

*Insertion of an inflatable balloon is a non-surgical procedure that can be performed as an outpatient using a local anaesthetic injection to numb the area. It involves making a passage through which the pus can drain over 4 weeks.*

**New**

## Corson Myoma Polyp Grasping Forceps

Experience precision and reliability with our Polyp Grasping Forceps, designed for superior performance in polyp removal procedures. Engineered with high-quality stainless steel, these forceps ensure exceptional durability and longevity.

### Key Features:

- Precision Grip: Fine-tipped design for secure and accurate grasping of polyps.
- Ergonomic Handle: Comfortable, non-slip grip reduces hand fatigue during extended use.
- Enhanced Control: Smooth operation for seamless maneuverability in delicate procedures.

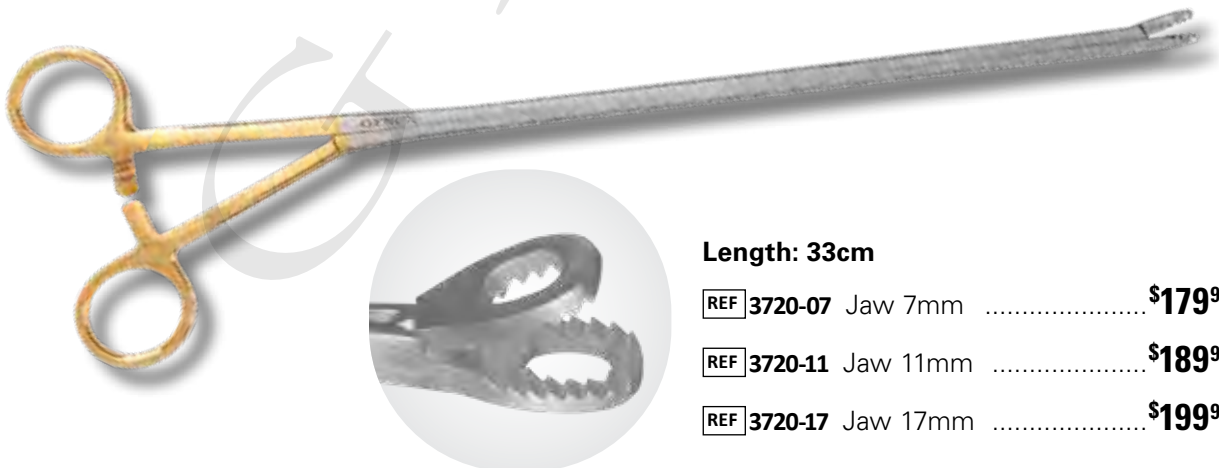

**Length: 33cm**

REF 3720-07	Jaw 7mm	.....	<b>\$179<sup>95</sup></b>
REF 3720-11	Jaw 11mm	.....	<b>\$189<sup>95</sup></b>
REF 3720-17	Jaw 17mm	.....	<b>\$199<sup>95</sup></b>



## Keyes Vulvar Punch

Features a sharpened round tip, ideal for obtaining vertical core samples from the vulvar epithelium. Designed with a sturdy handle specifically for easy ejection of lodged specimens.

● **2mm Tip**

REF 1302 ..... \$49<sup>95</sup>

● **3mm Tip**

REF 1303 ..... \$49<sup>95</sup>

● **4mm Tip**

REF 1304 ..... \$49<sup>95</sup>

● **5mm Tip**

REF 1305 ..... \$49<sup>95</sup>

● **6mm Tip**

REF 1306 ..... \$49<sup>95</sup>

● **7mm Tip**

REF 1307 ..... \$49<sup>95</sup>



## Keyes Vulvar Punch Single-Use

STERILE EO Single-Use

Not made with natural rubber latex.

This Single-Use Keyes Vulvar biopsy punch has a ribbed sturdy handle for maximum control and comfort. Box of 25.

● **2mm Tip**

REF 1322 ..... \$52<sup>95</sup>

● **3mm Tip**

REF 1323 ..... \$52<sup>95</sup>

● **4mm Tip**

REF 1324 ..... \$52<sup>95</sup>

● **5mm Tip**

REF 1325 ..... \$52<sup>95</sup>

● **6mm Tip**

REF 1326 ..... \$52<sup>95</sup>



## Keyes Vulvar Punch Set

This essential Keyes Vulvar Punch set includes a sturdy universal handle with six high quality stainless steel interchangeable screw tips, ranging from 2mm to 7mm in diameter. The set comes in a storage case with numerically designated holding pins for each tip to stabilize tip while attaching handle. **Tip Sizes:** 2mm - 7mm

REF 1310 Set..... \$229<sup>95</sup>



## Keyes Punch Accessories Kit

The perfect accessory kit for your Keyes Punch set. This kit includes a small forceps for lifting the tissue sample and a pair of scissors for snipping it off. The diamond-coated sharpening stone will keep your Keyes punches like new.

**Each Kit Contains:**

- Small Pick-Up Forceps
- Small Scissors
- Diamond Coated Sharpening Stone

REF KPA1315 ..... \$99<sup>95</sup>



# Patel™

## Multi-Use Forceps

New

The one instrument that every gynecologist needs in their practice. With its patent-pending design, the Patel™ excels at multiple functions!

REF NHL3450 ..... \$119<sup>95</sup>



Atraumatic, Waffle Pattern  
Jaw Provides Greater Grip

Off-Centered Tip Provides Better  
Visualization During Procedures

Ratchet Handle

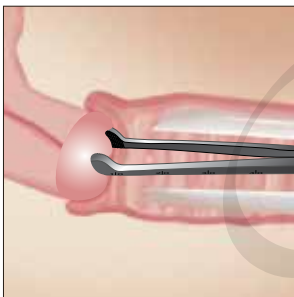

Atraumatic Tissue Grasper

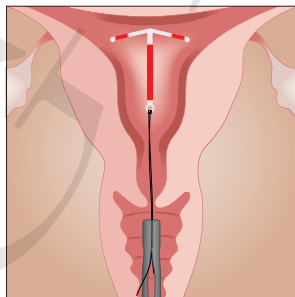

IUD Remover

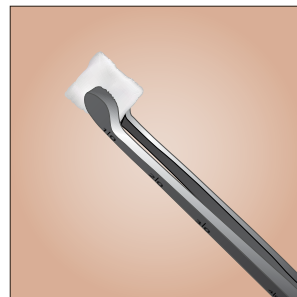

Sponge Forceps

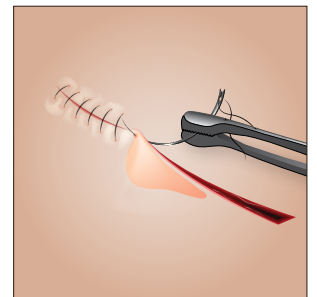

Needle Holder

## ONYX IUD String Scissors

**Blunt Tip, Slight Curve, Fine Serration**

Onyx Titanium Coated Stainless Steel

### KEY ADVANTAGES

- Incomparable cutting-edge hardness
- Extremely rust and corrosion resistant
- Smoother mechanical action
- Low friction coefficient

Length: 25cm

REF 29-040 ..... \$119<sup>95</sup>



*Our popular IUD String Scissors are now more durable and sharper than ever!*



## IUD String Scissors

**Blunt Tip, Slight Curve, Fine Serration**

High Quality Stainless Steel

Length: 25cm

REF 29-030 ..... \$89<sup>95</sup>



VILLA™

## Hormonal Implant Dissecting Forceps

New

The Villa™ Hormonal Implant Dissecting Forceps and Implant Remover make the perfect pair in the event that an implant is not visible upon incision. After making an incision, some implants remain difficult or impossible to view. If this is the case, the dissecting forceps, with pointed tip, can be opened and closed to separate the tissue encapsulating the implant. This will allow the remover to grasp, hold, and retract the implant.

### Villa™ Hormonal Implant Dissecting Forceps

REF 29-700 ..... \$59<sup>95</sup>

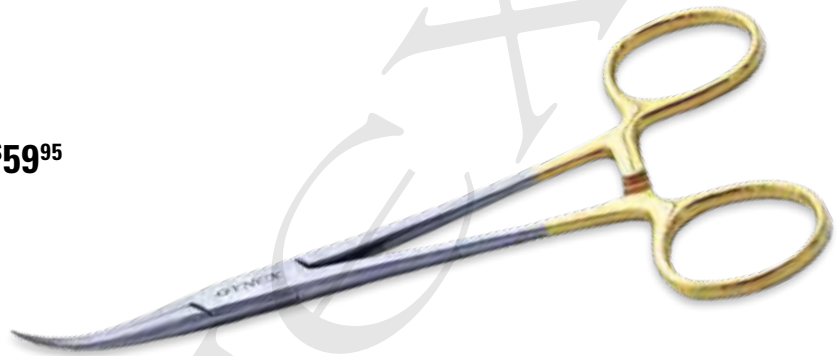

*Designed to aid with dissection  
of a contraceptive implant  
prior to removal.*

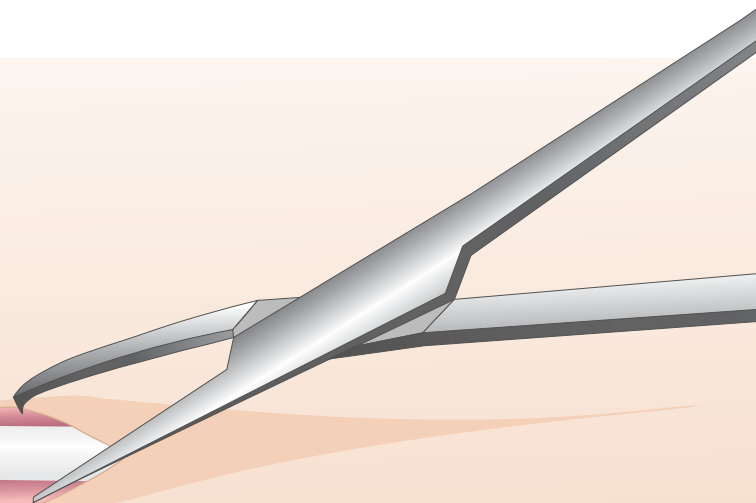

VILLA™

## Hormonal Implant Remover

New

The Villa™ Hormonal Implant Remover is a clamp specially designed to grasp, hold, and retract a contraceptive implant located in the arm, such as Nexplanon®. A small, ring tip secures around the mid-point of the implant for modified "U" technique.

### Villa™ Hormonal Implant Remover, Straight

REF 29-800 ..... \$62<sup>95</sup>

### Villa™ Hormonal Implant Remover, Angled

REF 29-900 ..... \$62<sup>95</sup>

### Villa™ Hormonal Implant Remover, Set

*Includes: 1 Straight, 1 Angled*

REF 29-850 ..... \$109<sup>95</sup>



*Designed to grasp, hold, and retract a contraceptive implant located in the arm, such as Nexplanon®, using a modified "U" technique.*

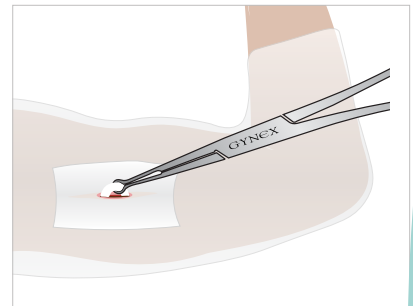
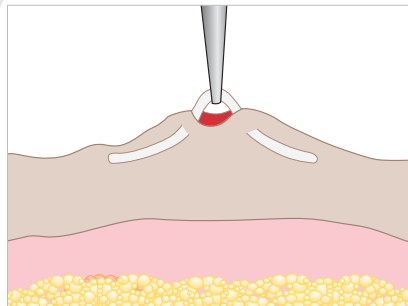
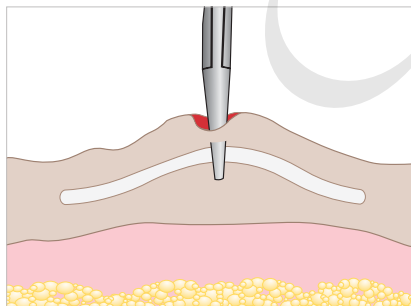

## IUD String Scissors, Single-Use

STERILE EO Single-Use

Not made with natural rubber latex.

### Metal Tip / Plastic Handle

- Handle features guide to reduce splaying

Length: 26.5cm

REF 29-065 Box of 12 ..... \$59<sup>95</sup>



## Gynex® Alligator Grasper

### Blunt tip, Fine Serrated Teeth

High Quality Stainless Steel

Perfect for grasping IUD strings

Length: 23cm

Available in Two Jaw Size

REF 29-100 Jaw Size: 20mm ..... \$97<sup>95</sup>

REF 29-550 Jaw Size: 10mm ..... \$97<sup>95</sup>

Finely serrated teeth in the jaw secures the IUD string

GYNEX®  
Original!



## Serpentine Grasper IUD Remover

### Flexible Shaft, Small Tip, Grasping Teeth

High Quality Stainless Steel

#### KEY ADVANTAGES

- Flexible shaft offers over 360° of mobility
- Shaft holds desired position until reshaped
- Small tip provides easy access

Length: 20cm

Tip in closed position: 4.5mm

REF 29-010 ..... \$324<sup>95</sup>



## IUD Remover, Crochet Style, Single-Use

STERILE EO **Single-Use** 

Not made with natural rubber latex.

**Rounded Tip, Angled, Dual Grasping Slots**

Length: 26.5cm

REF 29-200 Box of 12 ..... **\$59<sup>95</sup>**



## Willows™ IUD String Snare, Single-Use

STERILE EO **Single-Use** 

Not made with natural rubber latex.

**Rounded Tip, Multiple Grasping Slots**

- High quality malleable plastic

Length: 27cm

REF 29-300 Box of 12 ..... **\$59<sup>95</sup>**



## IUD Remover, Crochet Style

**Rounded Tip, Angled, Dual Grasping Slots**

Length: 26cm

REF 29-020 ..... **\$84<sup>95</sup>**

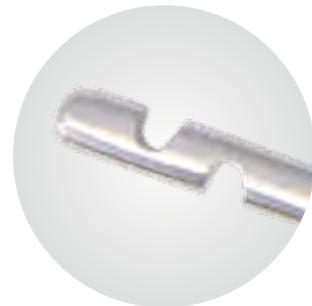

## Malleable IUD Remover, Crochet Style

**Rounded Tip, Angled, Dual Grasping Slots**

High Quality Malleable Metal

Length: 26cm

REF 29-025 ..... **\$94<sup>95</sup>**



## ASCONA™ IUD String Snare

**Effortless IUD Removal with Precision and Security**

The ASCONA™ IUD String Snare is expertly designed to ensure secure and efficient IUD removal. Simply twist the hook to and advance the coiled outer shaft to secure the string for removal. The ASCONA™ can be disassembled for thorough cleaning and sterilization. The flexible shaft and detachable hook make maintenance hassle-free.

REF 29-350 ..... \$87<sup>95</sup>

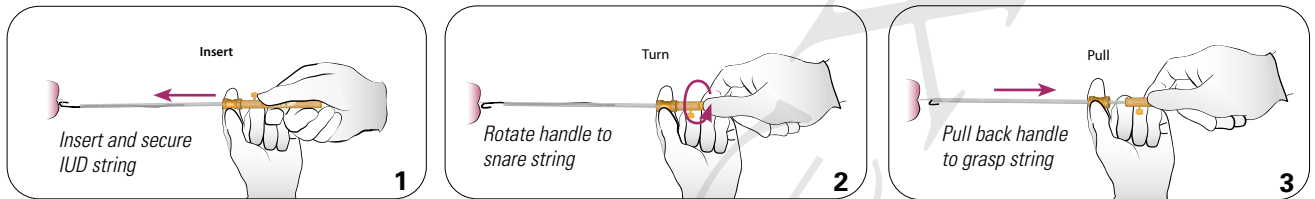

## Gynex® IUD Insertion Kit, Single-Use

STERILE EO Single-Use

Not made with natural rubber latex.

- Reduces the risk of transmission of infectious agents
- Eliminates costly instrument sterilization

**GYNEX®  
Original!**

REF 29-500 Box of 12..... \$218<sup>95</sup>

### EACH KIT TRAY CONTAINS:

- (1) Tenaculum Forceps
- (1) IUD String Scissor
- (2) Rayon Swabs
- (1) ACCU-SOUND® Uterine Sound
- (1) Folded Drape





# Uterine Sounds

## ACCU-SOUND® Uterine Sound, Single-Use

STERILE EO Single-Use

Not made with natural rubber latex.

The simple yet ingenious design of the ACCU-SOUND® Uterine Sound eliminates the guesswork involved with a standard uterine sound. When inserting the ACCU-SOUND® into the uterus, the ring rests against the outside of the Os. When the device is withdrawn from the uterus and vagina, the ring stays in place, clearly indicating the uterine measurement.

**Length:** 24cm

**Shaft Diameter:** 3mm

REF 4950 Box of 25 ..... \$79<sup>95</sup>



Not Shown at Actual Size

**1**  
Gently insert ACCU-SOUND® uterine sound's dilating tip into the cervical Os.



**2**  
Gently advance the ACCU-SOUND® Uterine Sound until the back of the uterus is felt.  
*ACCU-SOUND® Uterine Sound ring will rest against the outside of the cervical Os.*



**3**  
Withdraw ACCU-SOUND® Uterine Sound from the uterus and vagina. The ring will remain in place on the uterine sound indicating the uterus measurement.



*An accurate measurement is indicated by the location of the ring on the ACCU-SOUND® Uterine Sound*

## Sims Sound • flex, Single-Use

STERILE EO Single-Use

Not made with natural rubber latex.

GYNEX®  
Original!

New

Gynex has improved the Sims Sound. Engineered from specifically formulated memory polymer, the Sims Sound Flex formable shaft enhances the providers ability to pre-shape the sound to meet each patient's unique physical requirements. Bold, laser-etched markings along the shaft provide clear, reliable measurements.

- Formable Memory Polymer
- OD 4mm

**Working Length:** 16.6cm

REF 4630 Box of 25 ..... \$57<sup>95</sup>

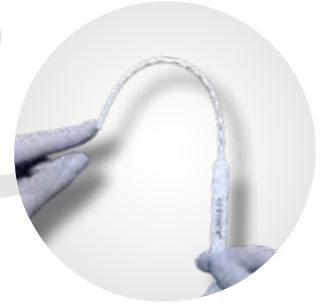

Not Shown at Actual Size

## Sims Sound Plus+, Single-Use

STERILE EO Single-Use

Not made with natural rubber latex.

- Malleable plastic
- OD 4mm

**Length:** 24cm

REF 4675 Box of 25 ..... \$66<sup>95</sup>



Not Shown at Actual Size

## Sims Sound, Single-Use

STERILE EO Single-Use

Not made with natural rubber latex.

- Malleable plastic
- OD 4mm

**Length:** 16.6cm

REF 4601 Box of 25 ..... \$57<sup>95</sup>



Not Shown at Actual Size

## Sims Sound, REUSABLE

- Autoclavable
- OD 4mm

**Length:** 32cm

REF 4334 Stainless Steel, Non-Malleable ..... \$47<sup>95</sup>

REF 4336 Stainless Steel, Malleable ..... \$52<sup>95</sup>



Not Shown at Actual Size

# Uterine Dilators

## Mini Dilator Set

**Set of 5 inter-changeable Probes and 1 Handle**

High Quality Stainless Steel

**Sizes:** 1mm, 1.5mm, 2mm, 2.5mm and 3mm

**REF 4005** Set..... **\$182<sup>95</sup>**

*Dots show actual diameter in mm*



*Especially useful for nulliparous patients*

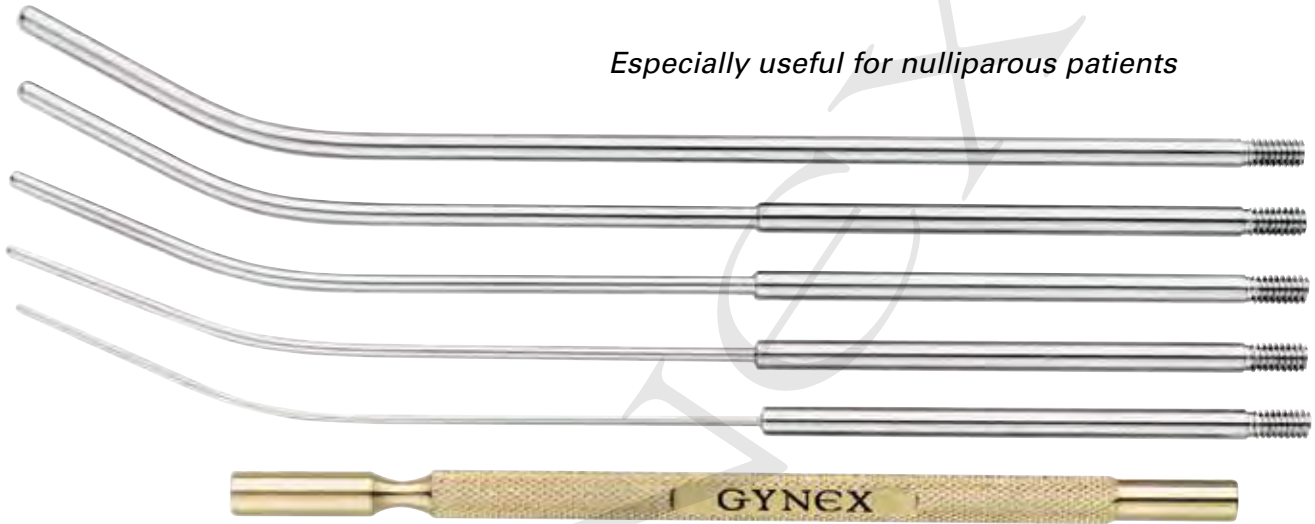

## Extra Mini Dilator Tips

(Fits **REF 4005** Handle)

**Sizes:** 1.5mm, 2.5mm, 4mm and 5mm

Available only from GYNEX

- REF 4005.1.5** 1.5mm ..... **\$47<sup>95</sup>**
- REF 4005.2.5** 2.5mm..... **\$47<sup>95</sup>**
- REF 4005.4** 4mm..... **\$47<sup>95</sup>**
- REF 4005.5** 5mm..... **\$47<sup>95</sup>**



*Dots show actual diameter in mm*



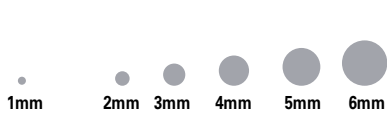

Dots show actual diameter in mm

### Small Dilator Set of 6 Probes

- Each probe is one size
- Stainless Steel

**Length:** 19.2cm

**REF 4008** Set **\$182<sup>95</sup>**

**Sold individually \$47<sup>95</sup>**

### Hank Dilator Set of 6 Probes

- Dual size on each dilator
- Stainless Steel

**Length:** 26.9cm

**REF 4010** Set..... **\$187<sup>95</sup>**

**Sold individually \$47<sup>95</sup>**

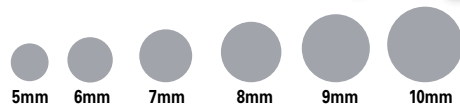

## Hegar Dilator Set of 8 Dilators

- Dual sizes on each dilator
- Stainless Steel

**Length:** 21cm

REF DHU3800 Set ..... **\$197<sup>95</sup>**



*Dots show actual diameter in mm*

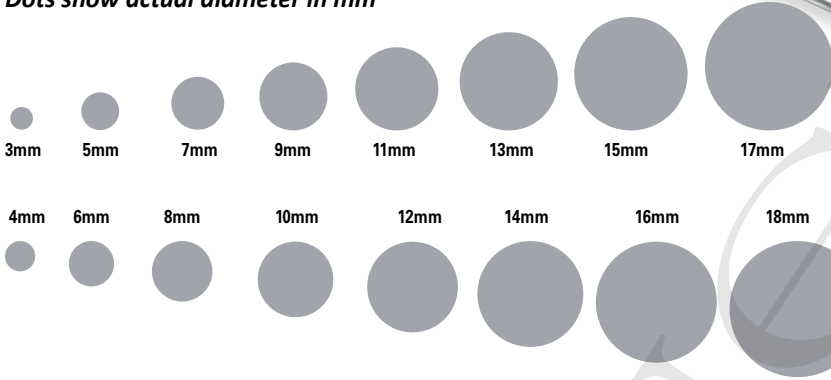

*\*Product not shown at actual size*

## Pratt Dilator Set of 8 Dilators

- Dual sizes on each dilator
- Stainless Steel

**Length:** 29.5 cm

REF DPU3850 Set ..... **\$199<sup>95</sup>**

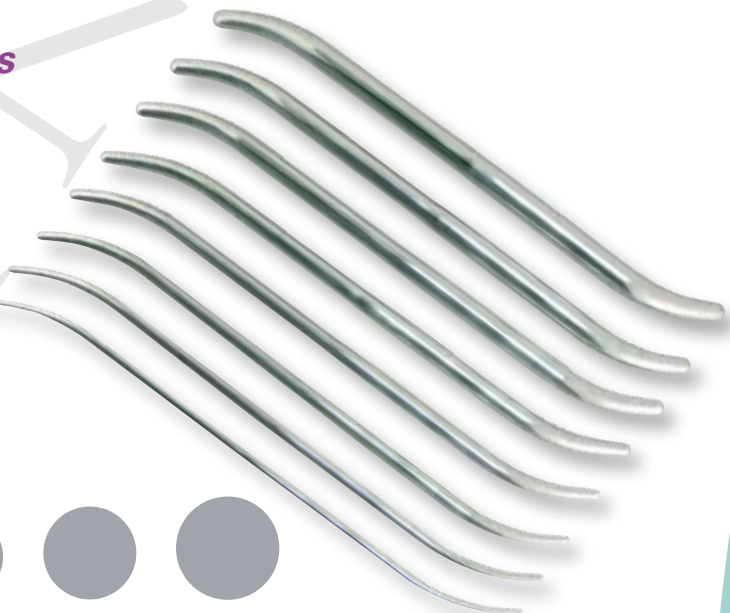

*Dots show actual diameter in mm*

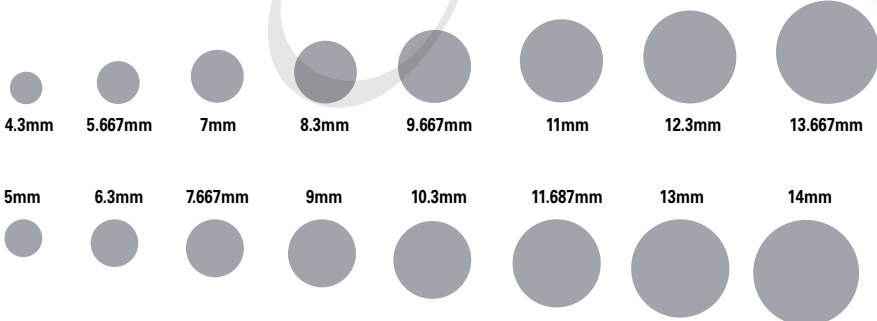

*\*Product not shown at actual size*

# Soft Dilators, Single-Use

STERILE EO **Single-Use**  
 Not made with natural rubber latex.

Designed to dilate the cervical canal to allow entry into the uterus for evaluation of the cervical canal or uterine cavity. These color coded dilators are soft and malleable allowing the operating physician to dilate with excellent control.

## Soft Dilator, Os Locator

*Used for locating the external Os by gently pushing the tip against the cervix.*

Tapered Tip Length: 23mm

Overall Length: 21.5cm

- REF 4211 Box of 12 ..... \$62<sup>95</sup>
- REF 4221 Box of 24 ..... \$114<sup>95</sup>

## Soft Dilator, Canal Finder

*Used for indicating the cervical canal.*

Tapered Tip Length: 45mm

Overall Length: 21.5cm

- REF 4212 Box of 12 ..... \$62<sup>95</sup>
- REF 4222 Box of 24 ..... \$114<sup>95</sup>

## Soft Dilator, Fundus Finder

*Used for establishing the entire length of the cervical canal from external Os to the internal Os.*

Tapered Tip Length: 85mm

Overall Length: 21.5cm

- REF 4213 Box of 12 ..... \$62<sup>95</sup>
- REF 4223 Box of 24 ..... \$114<sup>95</sup>

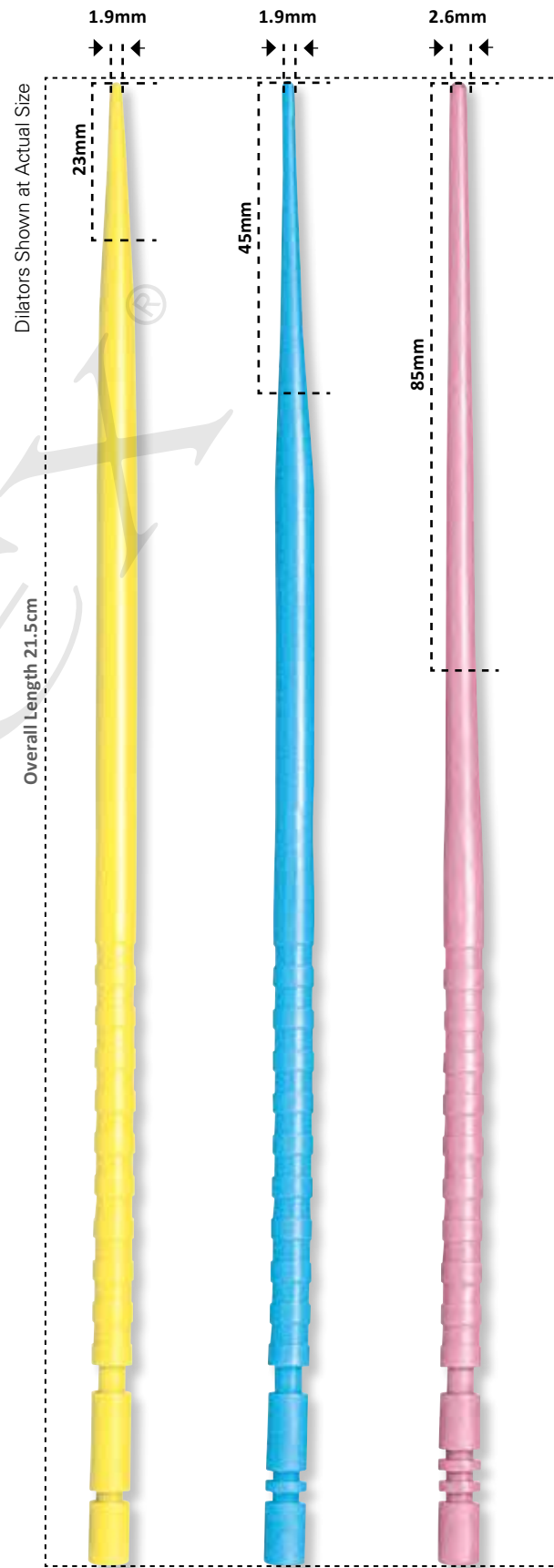

**Os Locator** Single-Use **Canal Finder** Single-Use **Fundus Finder** Single-Use

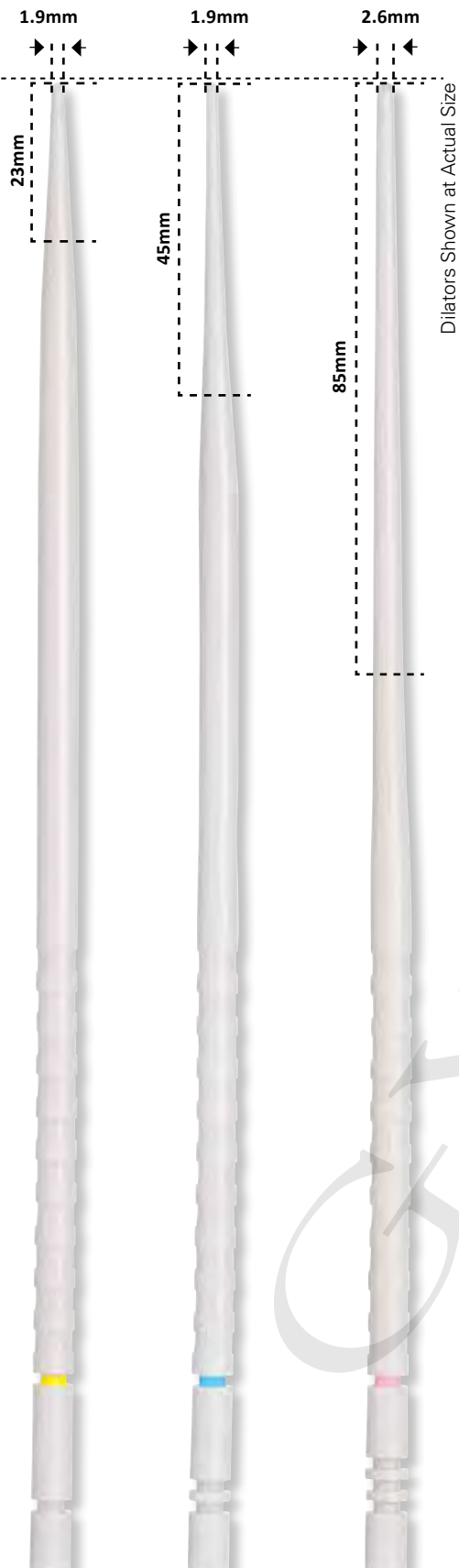

Dilators Shown at Actual Size

## Soft Teflon Dilators, REUSABLE

Designed to dilate the cervical canal to allow entry into the uterus for evaluation of the cervical canal or uterine cavity. These Soft Teflon Dilators are reusable, fully autoclavable and can be sterilized after use. Each of these three dilators are comfortable to hold and allow the operating physician to dilate with excellent control.

### Soft Teflon Dilator, **Os Locator**

**Tapered Tip Length:** 23mm

**Overall Length:** 21.5cm

REF 4201 ..... \$49<sup>95</sup>

### Soft Teflon Dilator, **Canal Finder**

**Tapered Tip Length:** 45mm

**Overall Length:** 21.5cm

REF 4202 ..... \$49<sup>95</sup>

### Soft Teflon Dilator, **Fundus Finder**

**Tapered Tip Length:** 45mm

**Overall Length:** 21.5cm

REF 4203 ..... \$49<sup>95</sup>



STERILE / Reusable  
OK to Autoclave

**Great Value!**

**SAVE on a SET of 3 Dilators**



STERILE / Reusable  
OK to Autoclave

## Soft Teflon Dilators Set, REUSABLE

**Set of three includes:** one Os Locator, one Canal Finder and one Fundus Finder.

REF 4200 Set of 3 ..... \$99<sup>95</sup>

**Os Locator** Reusable  
**Canal Finder** Reusable  
**Fundus Finder** Reusable

Note: Multi-Colored Single-Use <sup>®</sup> and the White Reusable Soft Dilators are the same shape and are intended for identical use.

5% Discount on Prepaid Orders by Check or ACH payment (offer excludes microscopes, colposcopes and/or extended warranties).

# Dennis Dilators<sup>®</sup>, Single-Use

STERILE EO Single-Use<sup>®</sup>

Not made with natural rubber latex.

5mm to 12mm

- Dual sizes on each dilator
- Diameter marked on handle for easy identification
- Ergonomic handle

**Overall Length:** 27cm

## 5-6mm Dilator

REF 4240 Box of 12 ..... **\$64<sup>95</sup>**

## 7-8mm Dilator

REF 4245 Box of 12 ..... **\$64<sup>95</sup>**

## 9-10mm Dilator

REF 4250 Box of 12 ..... **\$64<sup>95</sup>**

## 11-12mm Dilator

REF 4255 Box of 12 ..... **\$64<sup>95</sup>**

## Procedure Blister Tray

- Safe and Secure
- Sterile
- Easy Open Cover



Dots show actual diameter in mm

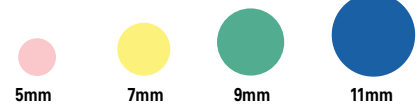



# Dennis Dilators® Set, REUSABLE

STERILE EO

Not made with natural rubber latex.

5mm to 14mm

- Dual sizes on each dilator
- Diameter marked on handle for easy identification

**Overall length:** 28cm

**Great Value!**

**SAVE on a SET of 5 Dilators**

REF 4230 Set of 5 ..... **\$119<sup>95</sup>**



STERILE / Reusable  
OK to Autoclave

## Procedure Blister Tray

- Safe and Secure
- Sterile
- Easy Open Cover



Dots show actual diameter in mm

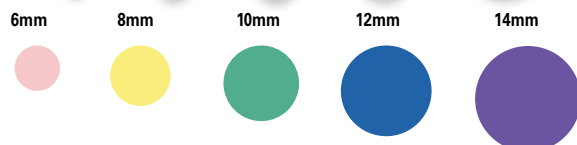
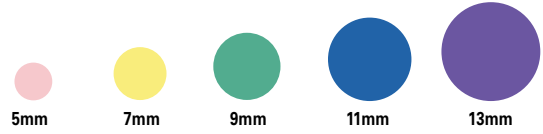

# Uterine Curettes

## Sims Uterine Curette

Sharp & Rigid

All Sims Uterine Curette Tips Shown at Actual Size



**Size 00**      **Size 0**      **Size 1**      **Size 2**      **Size 3**      **Size 4**      **Size 5**      **Size 6**

**REF CSU3900-9**  
**Size 00:** 10.5 x 4.0mm, Sharp, Rigid..... **\$74<sup>95</sup>**

**REF CSU3900-0**  
**Size 0:** 10.5 x 4.5mm, Sharp, Rigid..... **\$74<sup>95</sup>**

**REF CSU3900-1**  
**Size 1:** 13 x 5mm, Sharp, Rigid..... **\$74<sup>95</sup>**

**REF CSU3900-2**  
**Size 2:** 16 x 6mm, Sharp, Rigid..... **\$74<sup>95</sup>**

**REF CSU3900-3**  
**Size 3:** 16 x 7mm, Sharp, Rigid..... **\$74<sup>95</sup>**

**REF CSU3900-4**  
**Size 4:** 20 x 9mm, Sharp, Rigid..... **\$74<sup>95</sup>**

**REF CSU3900-5**  
**Size 5:** 22 x 9mm, Sharp, Rigid..... **\$74<sup>95</sup>**

**REF CSU3900-6**  
**Size 6:** 26 x 11mm, Sharp, Rigid..... **\$74<sup>95</sup>**



## Bumm Uterine Curette

Sharp & Rigid

All Bumm Uterine Curette Tips Shown at Actual Size



**Size 1**      **Size 2**      **Size 3**

**REF CBU3920-1**  
**Size 1:** 48 x 25mm ..... **\$72<sup>95</sup>**

**REF CBU3920-2**  
**Size 2:** 52 x 30mm ..... **\$72<sup>95</sup>**

**REF CBU3920-3**  
**Size 3:** 62 x 35mm ..... **\$72<sup>95</sup>**

# Century UMI™

## Uterine Manipulator/Injector

STERILE EO Single-Use

Not made with natural rubber latex.

The Century UMI™ Uterine Manipulator is easy-to-use and designed for patient safety. Optimized to support a broad procedural versatility: Laparoscopic Tubal Occlusion, Diagnostic Laparoscopy, Minilaparotomy, Salpingoplasty and Fertility Exams.

**Cannula Length:** 33cm

**OD:** 4.5mm

### Features

- Pear-shaped balloon for optimal hold
- Incorporated cervical stop (no spring!)
- Cannula to allow easy insertion
- Balloon forms an excellent seal at internal Os

*Now including a 10cc luer lock syringe for your convenience!*

REF 10-160 Box of 12 ..... **\$242<sup>95</sup>**

*Note: It is highly recommended that the practitioner utilize a sound to determine the patient's uterine depth prior to using any uterine manipulator/injector.*

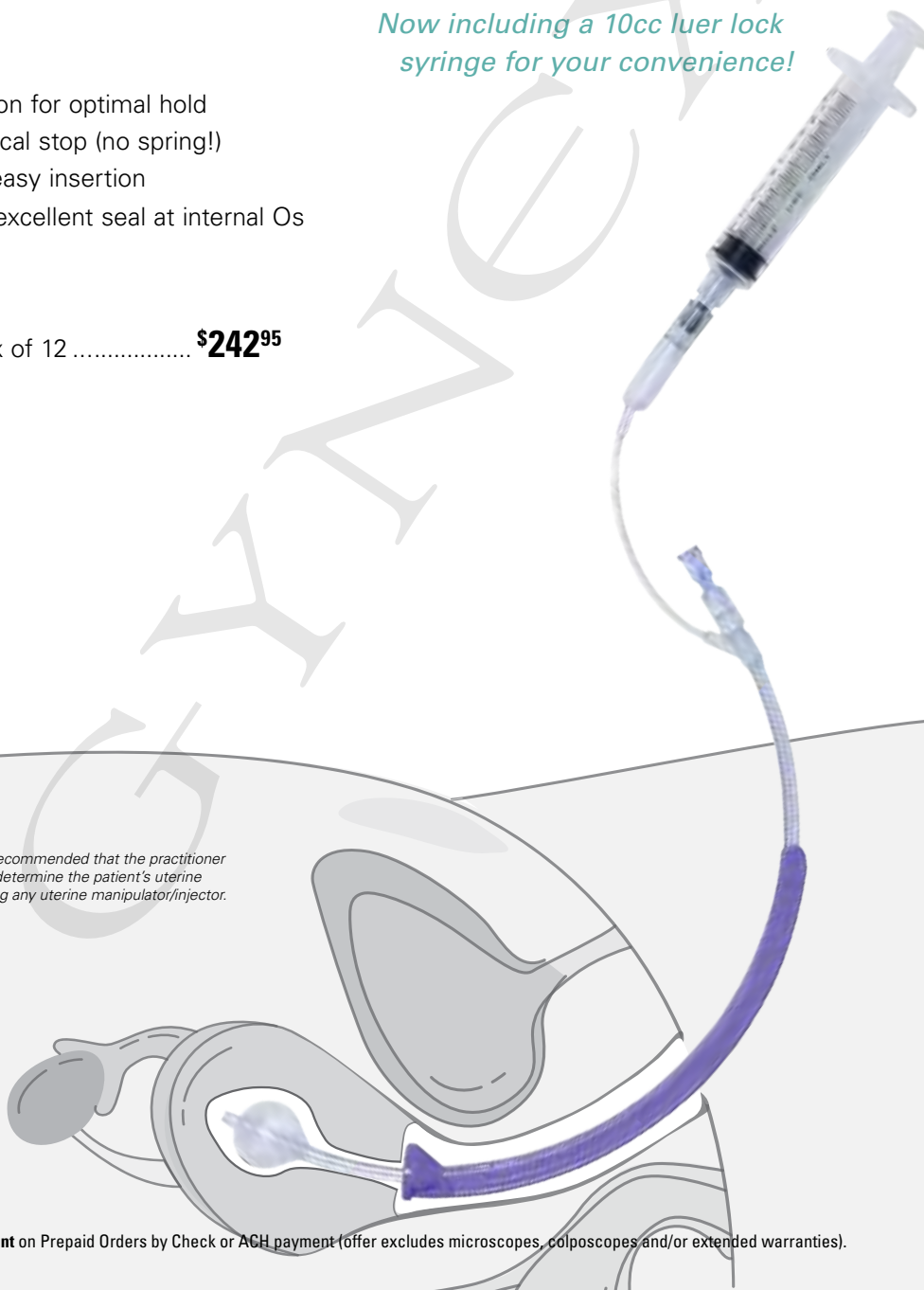

# sure@sample® • *Select 1*

## Endometrial Curette

STERILE EO Single-Use   
 Not made with natural rubber latex.

Suresample® *Select 1* is a uniquely designed curette for sampling the uterine endometrium, ideal for obtaining samples from the uterus and mucosal lining by scraping or vacuum suction.

**Cannula Length:** 8-1/8" (20.5cm)

**OD:** 3mm

### Features

- Randall-Style sharp cutting-edge
- Semi flexible curette with slight curve
- Easily readable 1cm markings on cannula
- White Cannula Stylet insert for additional rigidity
- Depth Marker acts as a visual aid to protect against perforation
- 10mL standard syringe with Twist-and-Lock plunger



<b>REF 3130</b>	Box of 5.....	<b>\$38<sup>95</sup></b>
<b>REF 3135</b>	Box of 24.....	<b>\$149<sup>95</sup></b>

*The unique design and special features allow for better accuracy and a more reliable sample.*

# sure@sample® • *Select 1*

## Endometrial Curette

### *Simple, Safe and Effective*

Tapered tip for easier insertion.  
Randall - Style sharp cutting edge.

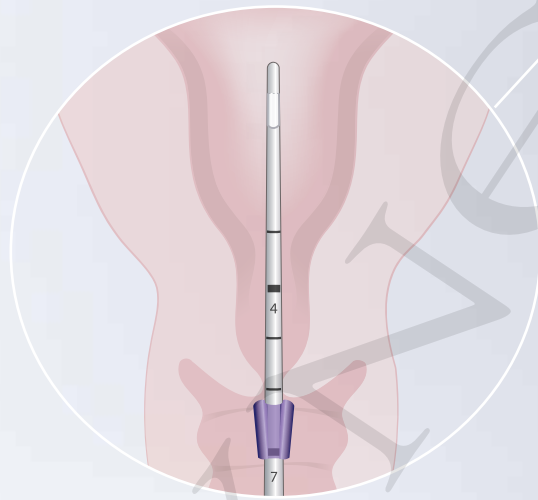

#### **DEPTH MARKER**

Set the desired curette marker depth after sounding the uterus.  
This depth marker acts as a visual aid to reduce the risk of perforation.

#### **TWIST AND LOCK PLUNGER**

The twist-and-lock plunger on the syringe allows the provider to maintain a constant vacuum pressure while collecting the specimen



# The endometrial sampler with a proven track record!

## **suresample**<sup>®</sup> Endometrial Sampler

The Suresample<sup>®</sup> Endometrial Sampler has been trusted by doctors for over **25 years**

Our **patented 3-port sampling system** doubles the harvested samples of tested competitors and allows **easy retrieval** with **reduced cell damage**. A much **greater histological adequacy and integrity** than any other samplers. 12 to 1 ratio of histological adequacy and 8 to 3 for histological integrity, Suresample<sup>®</sup> is the finest endometrial sampler.

Suresample<sup>®</sup> formable shaft memory allows the physicians to **pre-shape shaft** to meet each patient's unique physical requirements. Its tensile strength and rigidity make it malleable enough to conform to the direction of the cervix and lower segment, strong enough to access a tight canal. The formable 3mm shaft diameter enhances ease of use and minimizes patient discomfort.

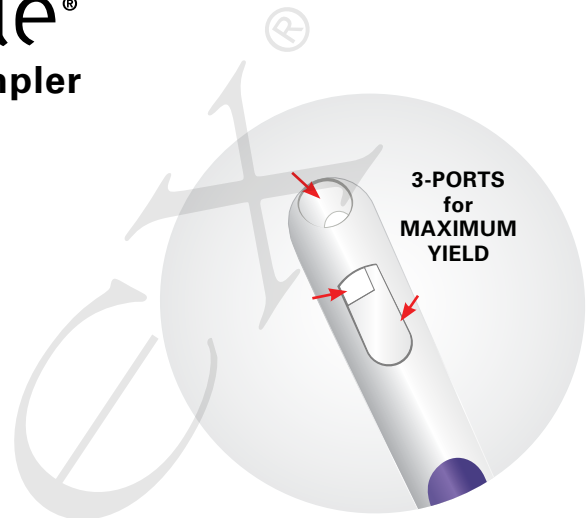

### AMOUNT OF BIOPSY TISSUE



Better performance than other brands

*Suresample<sup>®</sup> Endometrial Sampler retrieves more than twice the harvest of its competition!*

# sure@sample<sup>®</sup>

## Endometrial Sampler

STERILE EO Single-Use   
 Not made with natural rubber latex.

### Features and Benefits

- **3-Port Sampling System** - one port on each side of the distal end of the shaft and one on the tip end.
- **Grip retraction** creates a strong internal vacuum.
- **Two phase action** between the ports and grip produce a higher yield of tissue sample in an amazingly controlled manner.
- **Formable memory shaft** allows physician to shape the sampler to meet each patient's physical requirements.
- **Tensile strength and rigidity** allow conformity but also provide enough strength to access through a smaller canal.
- **No cutting or splitting of tip** (a tedious process required by other widely used samplers that leads to damaged specimen).
- **Quick retrieval process** - simply push the SURESAMPLE<sup>®</sup> Endometrial Sampler grip back, forcing the specimen out of the open sampler tip and sides.

**Shaft Diameter:** 3mm

**Shaft Length:** 24cm

REF 3115 Box of 25.....\$137<sup>95</sup>



Formable Shaft



Extended Piston

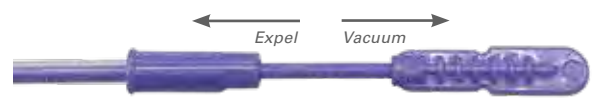

Outer Shaft Control Cuff

Grip

# Galileo® Colposcope Direct-Access™ 530VCDA

## Three-Step Magnification with Integrated LED Light and HD Video Camera

Designed with a patented offset center post for direct access, The Galileo Colposcope is a work of art in both form and function.

### Features

- Direct-Access™ Offset Center Post  
(Allows for unobstructed access to the examination site)
- Multi-Coated, Hand-Polished Apochromatic German Lens  
(Minimizes secondary color and corrects chromatic aberration)
- Integrated Power Source and Cables  
(Enclosed for a clean and clutter free look)
- Low voltage DC power  
(Eliminates the need to replace fuses)
- LED Illumination System  
(Accurate color balance, cool to the touch, long bulb life)
- Three-Step Magnification
- Observation Site Measurement Rings
- Individual Eye-Shields
- Integrated Green Filter
- HDMI Video  
(Allows for live feed and image/video capture)

### Options

- 360° Tilt Stand Base / 5-Wheel Rolling Stand Base
- Additional Extended Warranty

### Specifications

- Focal Length: ± 300mm
- Magnification: 3.75X, 7.5X, 15X
- Field Of View: 79mm, 39mm, 19mm
- Depth Of Field: 4.5mm, 1.13mm, 0.76mm
- Light Intensity: > 30,000 LUX
- Working Height: 975mm to 1135mm
- Power Supply: 100V to 240V
- Video Feed: HDMI-Video
- Warranty: 1 Year - Parts and Labor (excludes shipping charges)



with a 5-wheel Rolling Base

REF 530VCDA-R ..... **\$8,495<sup>00</sup>**

1 Year Extended Warranty

REF 530VCDA-T/R-1 ..... **\$600<sup>00</sup>**

with a 360° rotating Tilt Base

REF 530VCDA-T ..... **\$8,495<sup>00</sup>**

2 Year Extended Warranty

REF 530VCDA-T/R-2 ..... **\$875<sup>00</sup>**



Galileo Design Team is the Proud Recipient of the German • Red Dot Concept Design Award

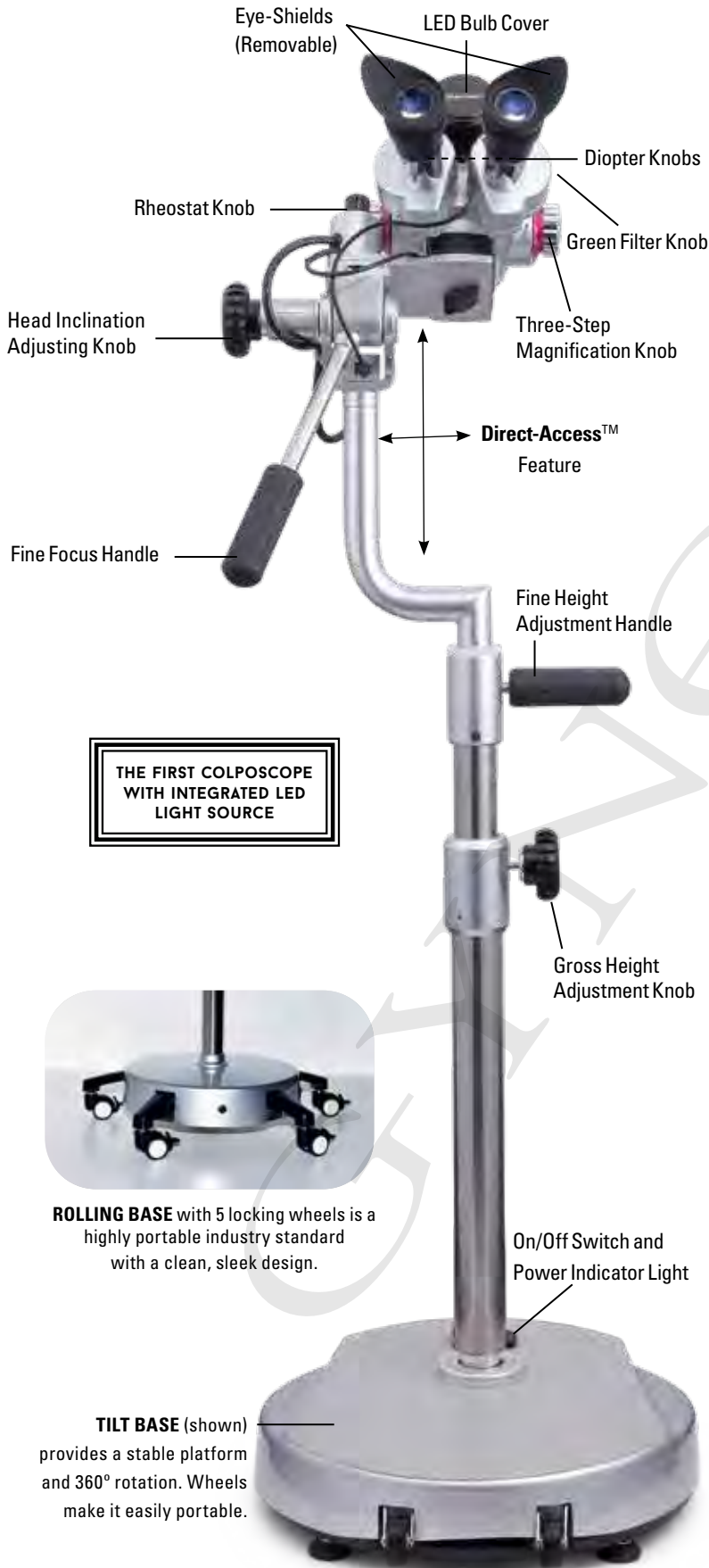

**Our colposcopes now utilize low-voltage DC power eliminating the need to replace fuses!**



**360° Tilt Base**  
Easy Maneuverability



**Superb German Optics**  
Apochromatic Lens  
High Resolution  
Large Depth of Field  
Wide Field of View  
Great Contrast  
3-D Image Reproduction



**LED Light Source**  
Lasts Longer  
Cool To The Touch  
Optimal Color Balance



**ROLLING BASE** with 5 locking wheels is a highly portable industry standard with a clean, sleek design.

**TILT BASE** (shown) provides a stable platform and 360° rotation. Wheels make it easily portable.



# Galileo® Colposcope Direct-Access™ 400DA

## Three-Step Magnification with Integrated LED Light

Designed with a patented offset center post for direct access, The Galileo Colposcope is a work of art in both form and function.

### Features

- Direct-Access™ Offset Center Post  
(Allows for unobstructed access to the examination site)
- Multi-Coated, Hand-Polished Apochromatic German Lens  
(Minimizes secondary color and corrects chromatic aberration)
- Integrated Power Source and Cables  
(Enclosed for a clean and clutter free look)
- Low voltage DC power  
(Eliminates the need to replace fuses)
- LED Illumination System  
(Accurate color balance, cool to the touch, long bulb life)
- Three-Step Magnification
- Observation Site Measurement Rings
- Individual Eye-Shields
- Integrated Green Filter

### Options

- 360° Tilt Stand Base / 5-Wheel Rolling Stand Base
- Additional Extended Warranty

### Specifications

- Focal Length: ± 300mm
- Magnification: 3.75X, 7.5X, 15X
- Field Of View: 79mm, 39mm, 19mm
- Depth Of Field: 4.5mm, 1.13mm, 0.76mm
- Light Intensity: > 30,000 LUX
- Working Height: 975mm to 1135mm
- Power Supply: 100V to 240V
- Warranty: 1 Year - Parts and Labor (excludes shipping charges)



with a 5-wheel Rolling Base

REF 400DA-R ..... \$6,595<sup>00</sup>

1 Year Extended Warranty

REF 400DA-T/R-1 ..... \$475<sup>00</sup>

with a 360° rotating Tilt Base

REF 400DA-T ..... \$6,595<sup>00</sup>

2 Year Extended Warranty

REF 400DA-T/R-2 ..... \$675<sup>00</sup>

Our colposcopes now utilize low-voltage DC power eliminating the need to replace fuses!



**360° Tilt Base**  
Easy Maneuverability



**Superb German Optics**  
Apochromatic Lens  
High Resolution  
Large Depth of Field  
Wide Field of View  
Great Contrast  
3-D Image Reproduction



**LED Light Source**  
Lasts Longer  
Cool To The Touch  
Optimal Color Balance



THE FIRST COLPSCOPE WITH INTEGRATED LED LIGHT SOURCE



**ROLLING BASE** with 5 locking wheels is a highly portable industry standard with a clean, sleek design.

**TILT BASE** (shown) provides a stable platform and 360° rotation. Wheels make it easily portable.

# Galileo® Colposcope Direct-Access™ 200DA

## Single Magnification with Integrated LED Light

Designed with a patented offset center post for direct access, The Galileo Colposcope is a work of art in both form and function.

### Features

- Direct-Access™ Offset Center Post  
(Allows for unobstructed access to the examination site)
- Multi-Coated, Hand-Polished Apochromatic German Lens  
(Minimizes secondary color and corrects chromatic aberration)
- Integrated Power Source and Cables  
(Enclosed for a clean and clutter free look)
- Low voltage DC power  
(Eliminates the need to replace fuses)
- LED Illumination System  
(Accurate color balance, cool to the touch, long bulb life)
- Single Magnification
- Observation Site Measurement Rings
- Individual Eye-Shields
- Integrated Green Filter

### Options

- 360° Tilt Stand Base / 5-Wheel Rolling Stand Base
- Additional Extended Warranty

### Specifications

- Focal Length: ± 300mm
- Magnification: 7.5X
- Field Of View: 39mm
- Depth Of Field: 1.13mm
- Light Intensity: > 30,000 LUX
- Working Height: 975mm to 1135mm
- Power Supply: 100V to 240V
- Warranty: 1 Year - Parts and Labor (excludes shipping charges)



with a 5-wheel Rolling Base

REF 200DA-R ..... \$5,195<sup>00</sup>

1 Year Extended Warranty

REF 200DA-T/R-1 ..... \$375<sup>00</sup>

with a 360° rotating Tilt Base

REF 200DA-T ..... \$5,195<sup>00</sup>

2 Year Extended Warranty

REF 200DA-T/R-2 ..... \$535<sup>00</sup>

Our colposcopes now utilize low-voltage DC power eliminating the need to replace fuses!



**360° Tilt Base**  
Easy Maneuverability



**Superb German Optics**  
Apochromatic Lens  
High Resolution  
Large Depth of Field  
Wide Field of View  
Great Contrast  
3-D Image Reproduction



**LED Light Source**  
Lasts Longer  
Cool To The Touch  
Optimal Color Balance



LED Bulb Cover  
Green Filter  
Diopter Knobs  
Optical Measurement Reference Chart  
Rheostat Knob  
Eye-Shields (Removable)

Head Inclination Adjusting Knob

**Direct-Access™**  
Feature

Fine Focus Handle

Fine Height Adjustment Handle

**THE FIRST COLPSCOPE WITH INTEGRATED LED LIGHT SOURCE**



**ROLLING BASE** with 5 locking wheels is a highly portable industry standard with a clean, sleek design.

On/Off Switch and Power Indicator Light

Gross Height Adjustment Knob

**TILT BASE** (shown) provides a stable platform and 360° rotation. Wheels make it easily portable.

# Accessories

for Galileo® Colposcope Direct-Access™ 530VCDA

## Video Capture Device

Connects Galileo® Colposcope 530VCDA to a PC for viewing and capturing images. Uses a USB 2.0 or 3.0 port on a computer.

**REF** VG-Magewell ..... **\$314<sup>95</sup>**



**Cut the Cord!**

Equipped with rechargeable battery.

## Gynex® Monitor

The Gynex® monitor is equipped with a built-in rechargeable battery for your convenience. It offers a convenient viewing option for patients and staff with one single cable connecting colposcope to the monitor.

Monitor with Rolling Base

**REF** 450MS ..... **\$3,095<sup>00</sup>**

Monitor Only

**REF** 450M ..... **\$374<sup>95</sup>**

(Note: Actual monitor shipped may be different than model shown)

# Galileo® Biological Microscope

## Specifications

- **Condenser Numerical Aperture:** Na = 1.25
- **Stage Movement Range:** Longitudinal 50mm, Transverse 75mm
- **Fine Focusing:** Minimum Division .002mm
- **Interpupillary Distance Adjustment Range:** 53–75mm
- **Light Source:** 6v / 20w Halogen Lamp, Adjustable Brightness

**Extended Warranties Available** (Excludes shipping charges)

**Clearer images  
and  
wider views  
at a great price!**

Eyepieces	10X Magnification	25mm Focus	Φ 18mm Field		
Objectives	Semi-Plan Achromatic				
	Magnification	4X	10X	40X	100X (oil)
	Total Magnification	40X	100X	400X	1000X
	N.A. (Numerical Aperture)	.1	.25	.65	1.25
	W.D. (mm)	23.1	4.1	.6	.38



## Components

- Plastic Carrying Case
- 2 Eyepieces
- 1 Extra Fuse
- 1 Extra Bulb
- 1 Dust Cover
- 1 Instructions for Use
- 1 Bottle of Immersion Oil

**Warranty:** 1 Year - Parts and Labor

Galileo Biological Microscope

REF MI-6000 ..... \$1,129<sup>95</sup>

1 Year Extended Warranty

REF MI-6000-1 ..... \$115<sup>00</sup>

2 Year Extended Warranty

REF MI-6000-2 ..... \$175<sup>00</sup>

# CO4100 Colposcope

## Three-Step Magnification, 45° Angle with Integrated LED Light

The CO4100 Colposcope features three-step magnification and 45° viewing angle with integrated LED light. The 45° angle lenses allow inclined viewing for a natural sitting position, reducing the need to bend over. The CO4100 Colposcope includes excellent optics designed to facilitate comprehensive cervical examination, with ease and style.

### Features

- Multi-Coated, Hand-Polished Apochromatic Lens  
(Minimizes secondary color and corrects chromatic aberration)
- Integrated Power Source and Cables  
(Enclosed in base and post for a clean and clutter free look)
- Low voltage DC power  
(Eliminates the need to replace fuses)
- LED Illumination System  
(Accurate color balance, cool to the touch, long bulb life)
- Three-Step Magnification
- Optical Measurement Rings
- Individual Eye-Shields
- Integrated Green Filter
- Adjustable Tension Ball-Joint for Easy 360° Motion

### Specifications

- Focal Length: ± 316mm
- Magnification: 3.75X, 7.5X, 15X
- Optical Angle: 45°
- Field Of View: 9.5mm, 19mm, 38mm
- Depth Of Field: 5mm, 8mm, 32mm
- Light Intensity: > 25,000LUX
- Working Height: 838mm to 1194mm (33" to 47")
- Power Supply: 90V to 240V
- Warranty: 1 Year - Parts and Labor (excludes shipping charges)

### Options

- Additional Extended Warranty



with a 360° rotating Tilt Base

**REF** CO4100-LED ..... **\$5,595<sup>00</sup>**

1 Year Extended Warranty

**REF** CO4100-1 ..... **\$450<sup>00</sup>**

2 Year Extended Warranty

**REF** CO4100-2 ..... **\$645<sup>00</sup>**



These circles indicate the millimeter size at the tissue site.

$\phi$ mm	A	B
3.75X	3.5	17
7.5X	2	8.8
15X	0.9	4.4



**Our colposcopes now utilize low-voltage DC power eliminating the need to replace fuses!**



**LED Light Source**  
 Lasts Longer  
 Cool To The Touch  
 Optimal Color Balance



**Universal Teflon Ball Joint**  
 360° Easy Maneuver

# CO3100 Colposcope

## Three-Step Magnification with Integrated LED Light

The CO3100 Colposcope features three-step magnification with integrated LED light. The device is compact, and light-weight with 360° tilt base for easy maneuverability. The CO3100 Colposcope includes excellent optics designed to facilitate comprehensive cervical examination, with ease and style.

### Features

- Multi-Coated, Hand-Polished Apochromatic Lens  
(Minimizes secondary color and corrects chromatic aberration)
- Integrated Power Source and Cables  
(Enclosed in base and post for a clean and clutter free look)
- Low voltage DC power  
(Eliminates the need to replace fuses)
- LED Illumination System  
(Accurate color balance, cool to the touch, long bulb life)
- Three-Step Magnification
- Optical Measurement Rings
- Individual Eye-Shields
- Integrated Green Filter
- Adjustable Tension Ball-Joint for Easy 360° Motion

### Specifications

- Focal Length: ± 316mm
- Magnification: 3.75X, 7.5X, 15X
- Field Of View: 9.5mm, 19mm, 38mm
- Depth Of Field: 5mm, 8mm, 34mm
- Light Intensity: > 25,000LUX
- Working Height: 838mm to 1194mm (33" to 47")
- Power Supply: 90V to 240V
- Warranty: 1 Year - Parts and Labor (excludes shipping charges)

### Options

- Additional Extended Warranty



with a 360° rotating Tilt Base

**REF** CO3100-LED ..... **\$4,995<sup>00</sup>**

1 Year Extended Warranty

**REF** CO3100-1 ..... **\$400<sup>00</sup>**

2 Year Extended Warranty

**REF** CO3100-2 ..... **\$575<sup>00</sup>**



**Our colposcopes now utilize low-voltage DC power eliminating the need to replace fuses!**



**LED Light Source**

- Lasts Longer
- Cool To The Touch
- Optimal Color Balance



**Universal Teflon Ball Joint**

- 360° Easy Maneuver

# CO1100 Colposcope

## Single Magnification with Integrated LED Light

The CO1100 Colposcope features 9x magnification. The device is compact and light-weight with a with 360° tilt base for easy maneuverability. The CO1100 Colposcope includes excellent optics designed to facilitate comprehensive cervical examination, with ease and style.

### Features

- Multi-Coated, Hand-Polished Apochromatic Lens  
(Minimizes secondary color and corrects chromatic aberration)
- Integrated Power Source and Cables  
(Enclosed in base and post for a clean and clutter free look)
- Low voltage DC power  
(Eliminates the need to replace fuses)
- LED Illumination System  
(Accurate color balance, cool to the touch, long bulb life)
- Single Magnification
- Optical Measurement Rings
- Individual Eye-Shields
- Integrated Green Filter
- Adjustable Tension Ball-Joint for Easy 360° Motion

### Specifications

- Focal Length: ± 316mm
- Magnification: 9X
- Field Of View: 22mm
- Depth Of Field: 8mm
- Light Intensity: > 25,000LUX
- Working Height: 838mm to 1194mm (33" to 47")
- Power Supply: 90V to 240V
- Warranty: 1 Year - Parts and Labor (excludes shipping charges)

### Options

- Additional Extended Warranty



with a 360° rotating Tilt Base

**REF** CO1100-LED ..... **\$3,595<sup>00</sup>**

1 Year Extended Warranty

**REF** CO1100-1 ..... **\$295<sup>00</sup>**

2 Year Extended Warranty

**REF** CO1100-2 ..... **\$415<sup>00</sup>**

	$\phi$ mm	A	B
		9X	1.5

These circles indicate the millimeter size at the tissue site.

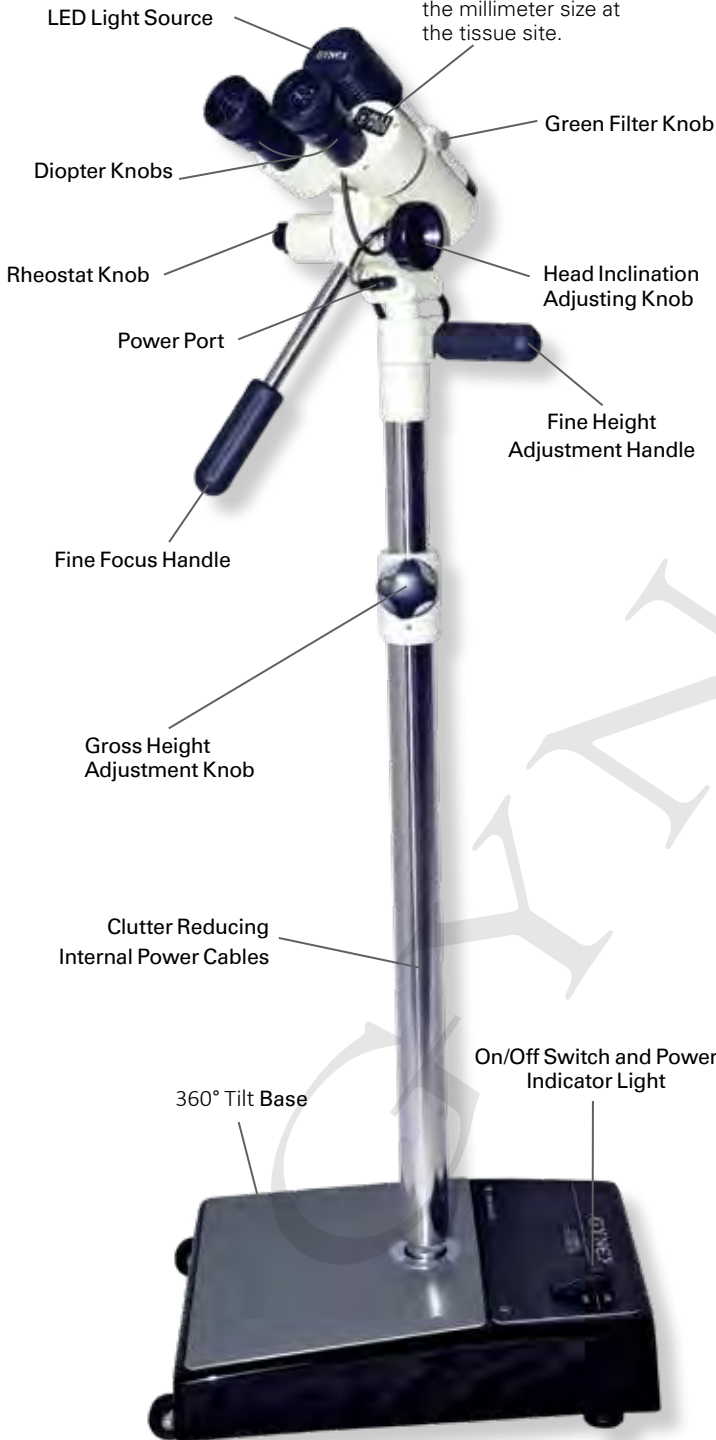

**Our colposcopes now utilize low-voltage DC power eliminating the need to replace fuses!**



**LED Light Source**

- Lasts Longer
- Cool To The Touch
- Optimal Color Balance



**Universal Teflon Ball Joint**

- 360° Easy Maneuver

# Galileo® Medical Exam Light

Experience the ultimate convenience and functionality of the Galileo® Medical Exam Light. Its **flexible neck** and adjustable design allow you to position the light exactly where you need it, providing optimal sharp illumination. Its **durable and aesthetically pleasing** design makes it a smart investment for any medical facility.

With **energy-efficient** LED bulb, the Galileo® Medical Exam Light is not only cost-effective but also long-lasting.

Ideal for hospitals, clinics, and private practices, the Galileo® Medical Exam Light is the perfect addition to any medical setting.

## Brighter and Cost Effective

- Features 1 white 3W LED for precise, high-output lighting
- Boasts a long lifetime of up to 50,000 hours and provides high illuminance of 70,000 Lux at a 200mm working distance
- Consumes less energy than traditional lighting options
- Eliminate the need for frequent bulb replacement



## True-to-Life Color Reproduction

- The lighting is easy on the eyes, providing a comfortable visual experience
- Delivers exceptional color rendering capabilities, ensuring that the illuminated area looks natural and highly contrasted



## Adjustable Spot Size

- Offers adjustable spot size with a diameter ranging from 15mm to 220mm, making it suitable for a wide range of situations and working distances, from 200mm to 1000mm
- Easy to clean, ensuring hassle-free maintenance



## Flexible Goose Neck

- An extremely flexible goose neck can be securely fixed in any position
- Features a two-segment design that allows for bending at any angle and any directions



## Medical Exam Light Accessories

### Table Mount

Mount the Galileo® Medical Exam Light to your table for additional floor space.



REF MEL-20 ..... \$104<sup>95</sup>

### Wall Mount

The Galileo® Medical Exam Light Wall Mount Bracket frees up floor space when necessary.



REF MEL-10 ..... \$94<sup>95</sup>



SCAN to SHOP

# Invest in the best and choose

# Galileo®

**REF MEL-50** ..... **\$579<sup>95</sup>**

## Touch-Guard® Single-Use Protective Sheath

Touch-Guard® Single-Use Sheaths protect your medical exam light and reduce the risk of contamination.

- Recommended to use with Galileo® Medical Exam Light **REF MEL-50**
- Can be used with most goose-neck exam lights under 4cm in diameter

**REF TG-300** Box of 25 ..... **\$14<sup>95</sup>**



# Hysterectomy Clamps

## Zephyr™ Titanium Rainbow™

Titanium Coated Hysterectomy Clamps

### Straight



REF TT580-21	21cm .....	<b>\$194<sup>95</sup></b>
REF TT580-24	24cm .....	<b>\$204<sup>95</sup></b>
REF TT580-27	27cm .....	<b>\$214<sup>95</sup></b>
REF TT580-30	30cm .....	<b>\$224<sup>95</sup></b>
REF TT580-36	36cm .....	<b>\$234<sup>95</sup></b>

### Slight Curve



REF TT585-21	21cm .....	<b>\$194<sup>95</sup></b>
REF TT585-24	24cm .....	<b>\$204<sup>95</sup></b>
REF TT585-27	27cm .....	<b>\$214<sup>95</sup></b>
REF TT585-30	30cm .....	<b>\$224<sup>95</sup></b>
REF TT585-36	36cm .....	<b>\$234<sup>95</sup></b>

### Angled

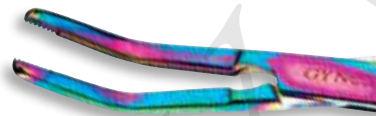

REF TT595-21	21cm .....	<b>\$194<sup>95</sup></b>
REF TT595-24	24cm .....	<b>\$204<sup>95</sup></b>
REF TT595-27	27cm .....	<b>\$214<sup>95</sup></b>
REF TT595-30	30cm .....	<b>\$224<sup>95</sup></b>
REF TT595-36	36cm .....	<b>\$234<sup>95</sup></b>

## The Original Zephyr™

Stainless Steel Hysterectomy Clamps

### Straight



REF 3580-21	21cm .....	<b>\$114<sup>95</sup></b>
REF 3580-24	24cm .....	<b>\$119<sup>95</sup></b>
REF 3580-27	27cm .....	<b>\$124<sup>95</sup></b>
REF 3580-30	30cm .....	<b>\$129<sup>95</sup></b>

### Slight Curve



REF 3585-21	21cm .....	<b>\$114<sup>95</sup></b>
REF 3585-24	24cm .....	<b>\$119<sup>95</sup></b>
REF 3585-27	27cm .....	<b>\$124<sup>95</sup></b>
REF 3585-30	30cm .....	<b>\$129<sup>95</sup></b>

### Strong Curve



REF 3590-21	21cm .....	<b>\$114<sup>95</sup></b>
REF 3590-24	24cm .....	<b>\$119<sup>95</sup></b>
REF 3590-27	27cm .....	<b>\$124<sup>95</sup></b>
REF 3590-30	30cm .....	<b>\$129<sup>95</sup></b>

### Angled



REF 3595-21	21cm .....	<b>\$114<sup>95</sup></b>
REF 3595-24	24cm .....	<b>\$119<sup>95</sup></b>
REF 3595-27	27cm .....	<b>\$124<sup>95</sup></b>
REF 3595-30	30cm .....	<b>\$129<sup>95</sup></b>



# Hysterectomy Scissors

## Titanium Rainbow™ Scissors

Titanium Coated Hysterectomy Scissors



### Slight Curve

REF TT680-20	20cm.....	\$97 <sup>95</sup>
REF TT680-23	23cm.....	\$99 <sup>95</sup>



### Full Curve

REF TT690-20	20cm.....	\$97 <sup>95</sup>
REF TT690-23	23cm.....	\$99 <sup>95</sup>



### Curve

REF TT685-20	20cm.....	\$97 <sup>95</sup>
REF TT685-23	23cm.....	\$99 <sup>95</sup>



### Angled

REF TT695-20	20cm.....	\$97 <sup>95</sup>
REF TT695-23	23cm.....	\$99 <sup>95</sup>

## Zephyr™ Scissors

Stainless Steel Hysterectomy Scissors



### Curve Scissors

REF 3685-20	20cm.....	\$97 <sup>95</sup>
REF 3685-23	23cm.....	\$99 <sup>95</sup>



### Angled Scissors

REF 3695-20	20cm.....	\$97 <sup>95</sup>
REF 3695-23	23cm.....	\$99 <sup>95</sup>



### Slight Curve Scissors

REF 3680-20	20cm.....	\$97 <sup>95</sup>
REF 3680-23	23cm.....	\$99 <sup>95</sup>



### Full Curve Scissors

REF 3690-20	20cm.....	\$97 <sup>95</sup>
REF 3690-23	23cm.....	\$99 <sup>95</sup>

# Scissors

## Iris Scissors

### Straight

REF S3816  
11cm Length.....\$36<sup>95</sup>



### Curved

REF S3814  
11cm Length.....\$39<sup>95</sup>



### Angled

REF S3812  
11cm Length.....\$42<sup>95</sup>



## Littaur Stitch Scissors

REF S3810 14cm Length.....\$27<sup>95</sup>



## Laminaria Insertion Forceps

Specifically designed for insertion of laminaria.

REF 1600 .....\$79<sup>95</sup>



# Needle Holders

## Webster Smooth Needle Holder

### Smooth jaw

REF NHW3400 13cm Length.....\$34<sup>95</sup>



## Mayo-Hegar Needle Holder

### Serrated jaw

REF NHMH3410-14 14cm Length.....\$34<sup>95</sup>

REF NHMH3410-16 16cm Length.....\$37<sup>95</sup>

REF NHMH3410-18 18cm Length.....\$39<sup>95</sup>

REF NHMH3410-20 20cm Length.....\$42<sup>95</sup>



## Crile-Wood Needle Holder

### Serrated jaw

REF NHCW3420-15 15cm Length.....\$37<sup>95</sup>

REF NHCW3420-18 18cm Length.....\$39<sup>95</sup>

REF NHCW3420-20 20cm Length.....\$42<sup>95</sup>

REF NHCW3420-23 23cm Length.....\$47<sup>95</sup>



## Electrode Extender

*Effectively Doubles the Shaft Length of Your Electrode*

STERILE EO **Single-Use**

Not made with natural rubber latex.

REF **12-0000** 13cm Length  
Box of 5 ..... **\$49<sup>95</sup>**



**ACCESS DEEP CAVITIES  
AND OTHER  
HARD-TO-REACH SITES**



## Electrode Handpiece, Hand Activated with VL Plug

*For use with standard removable electrodes*

STERILE EO **Single-Use**

Not made with natural rubber latex.

10 foot cable  
REF **755VL** Box of 12..... **\$116<sup>95</sup>**



## Electrode Handpiece, Foot Activated

*For use with standard removable electrodes*

STERILE EO **Single-Use**

Not made with natural rubber latex.

10 foot cable  
REF **950** Box of 12..... **\$96<sup>95</sup>**



*Actual size*

# Radius Loop Electrodes

Our Most Popular Style

STERILE EO **Single-Use**  
Not made with natural rubber latex.

All Electrode Tips Shown at Actual Size

REF **12-0505** 5mm x 5mm  
Box of 5..... **\$71<sup>95</sup>**



REF **12-1007** 10mm x 7mm  
Box of 5..... **\$71<sup>95</sup>**



REF **12-1010** 10mm x 10mm  
Box of 5..... **\$71<sup>95</sup>**



REF **12-1505** 15mm x 5mm  
Box of 5..... **\$71<sup>95</sup>**



REF **12-1508** 15mm x 8mm  
Box of 5..... **\$71<sup>95</sup>**



REF **12-1512** 15mm x 12mm  
Box of 5..... **\$71<sup>95</sup>**

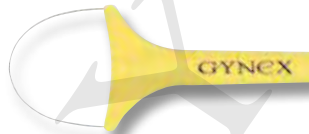

REF **12-1515** 15mm x 15mm  
Box of 5..... **\$71<sup>95</sup>**

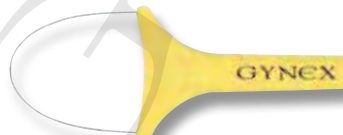

REF **12-2008** 20mm x 8mm  
Box of 5..... **\$71<sup>95</sup>**



REF **12-2010** 20mm x 10mm  
Box of 5..... **\$71<sup>95</sup>**



REF **12-2013** 20mm x 13mm  
Box of 5..... **\$71<sup>95</sup>**



REF **12-2015** 20mm x 15mm  
Box of 5..... **\$71<sup>95</sup>**



REF **12-2510** 25mm x 10mm  
Box of 5..... **\$71<sup>95</sup>**



REF **12-2515** 25mm x 15mm  
Box of 5..... **\$71<sup>95</sup>**



**Electrode Measurements**

REF **12-2015**  
Width Height

WHAT REFERENCE NUMBERS MEAN

# H-Series Loop Electrodes

Precision Depth and Width Control

STERILE EO Single-Use

Not made with natural rubber latex.



REF 13-1505 15mm x 5mm  
Box of 5 ..... \$71<sup>95</sup>



REF 13-2005 20mm x 5mm  
Box of 5 ..... \$71<sup>95</sup>



REF 13-1010 10mm x 10mm  
Box of 5 ..... \$71<sup>95</sup>



REF 13-2007 20mm x 7mm  
Box of 5 ..... \$71<sup>95</sup>



REF 13-2010 20mm x 10mm  
Box of 5 ..... \$71<sup>95</sup>

## Needle Electrode

For electro fulguration using coagulation power outputs

STERILE EO Single-Use

Not made with natural rubber latex.



REF 15-0001 26mm Long Needle  
Box of 5 ..... \$71<sup>95</sup>

All Electrode Tips Shown at Actual Size

## Square Loop Electrodes

STERILE EO Single-Use

Not made with natural rubber latex.



REF 19-1004 10mm x 4mm  
Box of 5 ..... \$71<sup>95</sup>



REF 19-1010 10mm x 10mm  
Box of 5 ..... \$71<sup>95</sup>

## Ball Electrodes

Ideal for hemostasis of bleeding sites and/or ablation of sub-surface lesions

STERILE EO Single-Use

Not made with natural rubber latex.



REF 2-3-2 3mm Diameter, 13.5cm Shaft  
Box of 5 ..... \$69<sup>95</sup>



REF 2-5-2 5mm Diameter, 13.5cm Shaft  
Box of 5 ..... \$69<sup>95</sup>

# GYNEX® Cone Electrodes

STERILE EO Single-Use

Not made with natural rubber latex.

## The Cone Electrode is a LLETZ excisor for precise cone biopsy specimens

Cone biopsy electrodes allow for smooth rotation, facilitating the removal of precise, cone-shaped specimens. The tungsten linear wires are 0.20mm thick to help reduce backward drag. Molded shaft and stop arm are completely insulated to protect the endocervical canal and underlying vaginal structures.

Each electrode is packaged in a molded blister tray which keeps the tip true to shape and protects from breakage.

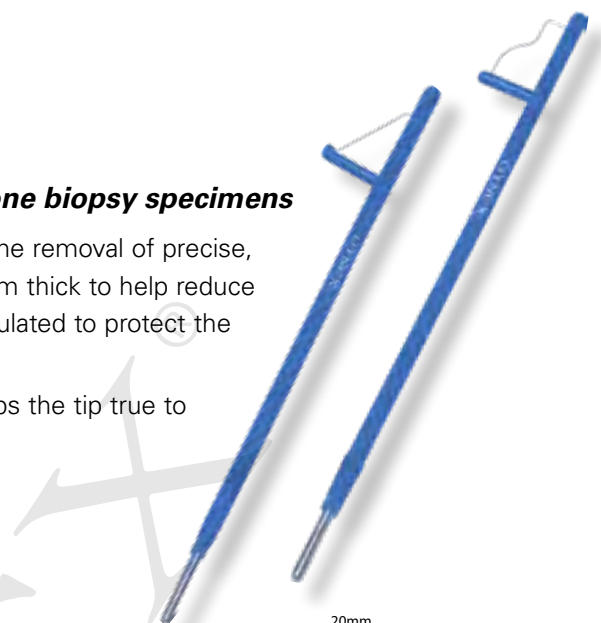

## Triangle Cone Electrode

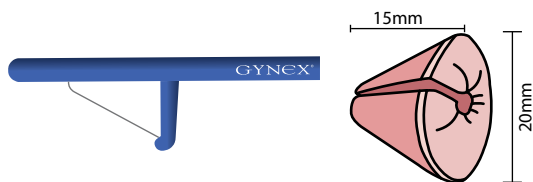

REF 14-1015 10mm Radius x 15mm Height  
Box of 5.....\$71<sup>95</sup>



REF 14-1020 10mm Radius x 20mm Height  
Box of 5.....\$71<sup>95</sup>

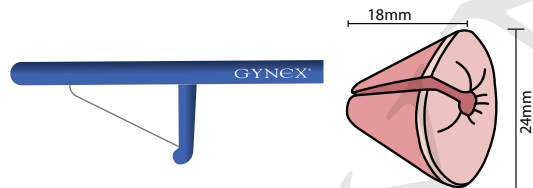

REF 14-1218 12mm Radius x 18mm Height  
Box of 5.....\$71<sup>95</sup>

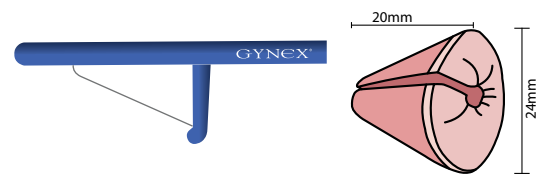

REF 14-1220 12mm Radius x 20mm Height  
Box of 5.....\$71<sup>95</sup>

## Contoured Cone Electrode



REF 17-1013 10mm Radius x 13mm Height  
Box of 5.....\$71<sup>95</sup>



REF 17-1018 10mm Radius x 18mm Height  
Box of 5.....\$71<sup>95</sup>

# Electrosurgical Patient Dispersive Pads

for LLETZ Procedures

NON-STERILE Single-Use®  
Not made with natural rubber latex.

## Standard Grounding Pad with Cord, Solid-Style

### Generators Compatibility

MANUFACTURES	PAD REF #
BEI® Plus II	395-302
CooperSurgical® LEEP® 1000	6050P
CooperSurgical® LEEP® 6000	6050P



Connector shown at ACTUAL SIZE

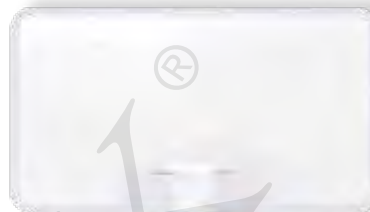

REF 6010

Box of 12.. \$109<sup>95</sup>

## Grounding Pad with Cord, Solid-Style

### Generators Compatibility

MANUFACTURES	PAD REF #
Utah Medical Finess II	
Utah Medical Finess®	ESU-405



Connector shown at ACTUAL SIZE



REF 21-809

Box of 12.. \$109<sup>95</sup>

## Grounding Pad with Cord, Split (REM)

### Generators Compatibility

MANUFACTURES	PAD REF #
ConMed® Sabre® 180	402-2204
Wallach® Quantum 2000, 500	909078
Utah Medical Finess® II**	ESU-420
Utah Medical Finess® +	



Connector shown at ACTUAL SIZE

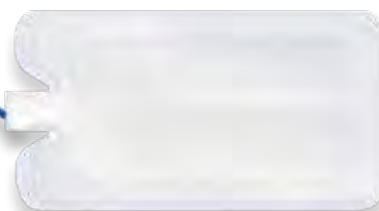

REF 33-714

Box of 12.. \$109<sup>95</sup>

# Bozeman Uterine Forceps

Bozeman Uterine Forceps are meticulously engineered with elongated, curved jaws to facilitate superior reach and control during uterine packing or tissue manipulation. This highly adaptable instrument is proficient in a range of applications, such as securing gauze and sponges, manipulating and managing tissues, extracting foreign objects or placental remnants, aiding in intrauterine device removal, and stabilizing sutures or tissues to enhance accessibility and procedural accuracy.

## The perfect tool for various situations!

- Holding gauze and sponges
- Grasping and handling tissues
- Removing foreign bodies or placental fragments
- Assisting in IUD removal
- Holding sutures or tissues for better access and precision

REF 3612 26cm Length..... **\$84<sup>95</sup>**

*Finely serrated tips to decrease trauma while providing a firm grip!*





## Extended Needle Adapters, Luer Hub, REUSABLE

*Extends the reach of hypodermic needles*

Stainless Steel

**Available Size:** 3–6 inch lengths

REF 5120 7.62cm (3") ..... **\$37<sup>95</sup>**



REF 5122 10.16cm (4") ..... **\$37<sup>95</sup>**



REF 5124 12.7cm (5") ..... **\$37<sup>95</sup>**



REF 5126 15.24cm (6") ..... **\$37<sup>95</sup>**

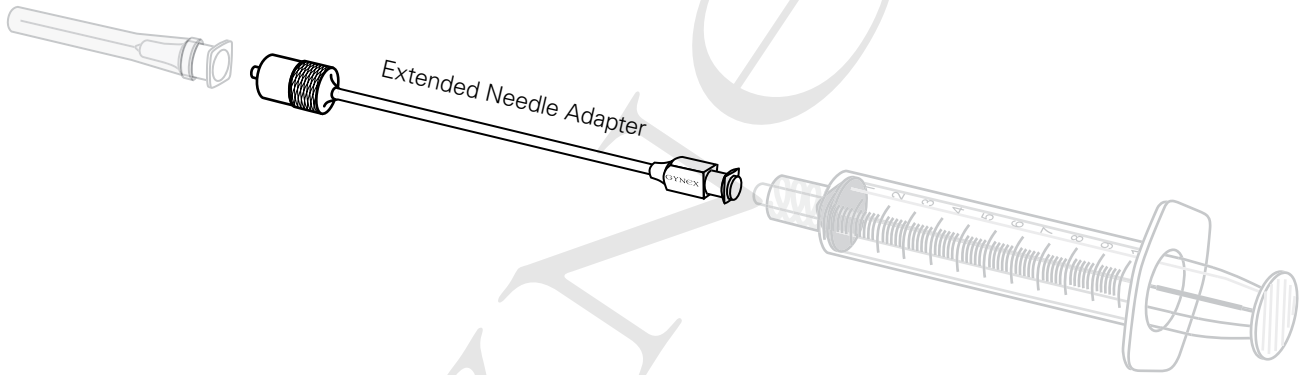

## Cartridge Syringe, Screw Hub, REUSABLE

NOTE: This does not work with the Extended Needle Adapter shown above.

REF 5210 ..... **\$54<sup>95</sup>**

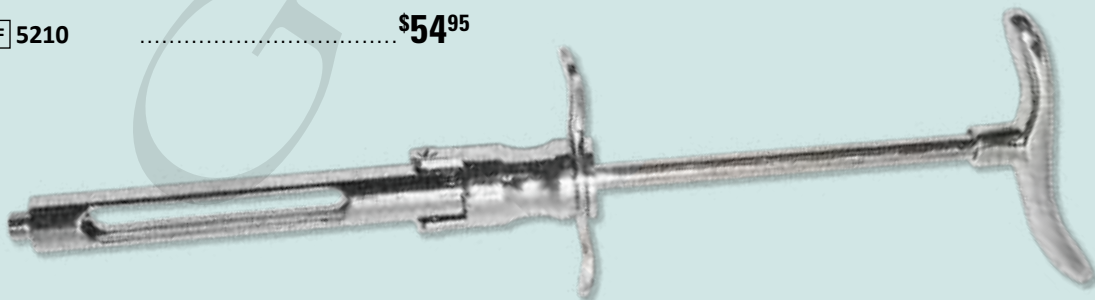

# Filter, Prefilter and Reducer

for Smoke Evacuation Systems

## Sterile Vacuum Tubing Sets, Single-Use

STERILE EO Single-Use

Not made with natural rubber latex.

Fits most smoke evacuation systems that use 1/2" OD.  
The 9' tubing is connected to DSE tubing which connects to the speculum as shown in the illustration above.

REF 8200 12 Sets..... **\$214<sup>95</sup>**



**Perfect match** for all smoke evacuators at a far more **reasonable price!**

## Prefilter Reducer, Single-Use

NON-STERILE Single-Use

Not made with natural rubber latex.

Fits into top of Prefilter (REF 8210), and adapts to .375" ID tubing (REF 8200 Tubing Set)

- Bottom opening is 1.33" OD
- Top opening is .375" OD
- Fits CooperSurgical 6080 Smoke Evacuator, with 8210 Prefilter

REF 8230 Qty 10 ..... **\$57<sup>95</sup>**

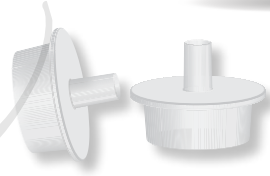

CONNECTS WITH

## Prefilter, Single-Use

NON-STERILE Single-Use

Not made with natural rubber latex.

- Fits CooperSurgical 6080 Smoke Evacuator
- Top opening is 1.33" ID
- Non-combustible

REF 8210 Qty 10 ..... **\$199<sup>95</sup>**



CONNECTS WITH

## ULPA Filter, Single-Use

NON-STERILE Single-Use

Not made with natural rubber latex.

- Maximum Life 90 Days
- Fits CooperSurgical 6080 Smoke Evacuator

REF 8215 ..... **\$199<sup>95</sup>** each



# Tubing and Connectors

for LLETZ Procedures

## Tubing Connector

NON-STERILE Single-Use

Not made with natural rubber latex.

Connects Clear-Flue™ to Flexible-S Tubing. 1/4" to 7/8"

REF 8100 Box of 12.... \$27<sup>95</sup>

## Flexible-S Tubing

NON-STERILE Single-Use

Not made with natural rubber latex.

Connects to DSE Tubing. 1/4" ID, 3/8" OD x 2'

REF 8024 Box of 6..... \$49<sup>95</sup>

## DSE Tubing

NON-STERILE Single-Use

Not made with natural rubber latex.

Attaches to specula with smoke evacuation clip.

Non-combustible, No PVC. 1/4" OD x 9"

REF 8009 Box of 50..... \$97<sup>95</sup>

## Clear-Flue™ Tubing

NON-STERILE Single-Use

Not made with natural rubber latex.

Attaches to either Flexible-S Tubing or to Sterile Vacuum Tubing. 7/8" OD x 66"

REF 8072 Qty 24..... \$77<sup>95</sup>

## Tubing Connector

NON-STERILE Single-Use

Not made with natural rubber latex.

Connects Clear-Flue™ to Sterile Vacuum Tubing. 3/8" to 7/8"

REF 8103 Box of 12.... \$29<sup>95</sup>

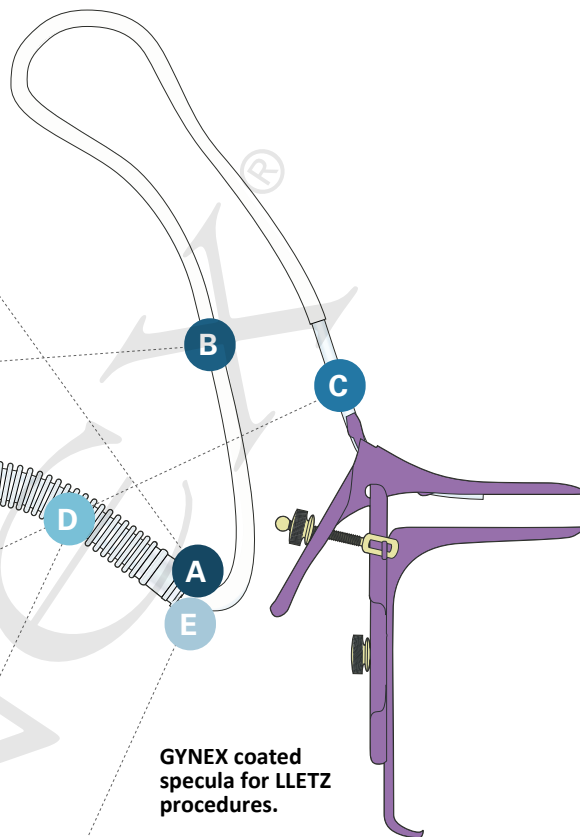
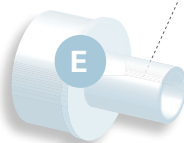
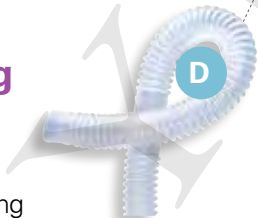
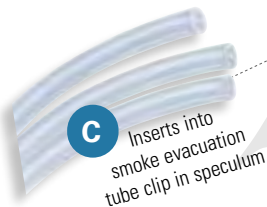
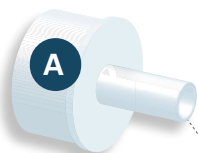

## Sterile Vacuum Tubing Sets, Single-Use

STERILE EO Single-Use

Not made with natural rubber latex.

Fits many popular smoke evacuation systems that use 1/2" OD. The 9'+ tube is connected to DSE tubing which connects to the speculum as shown in the illustration above.

REF 8200 12 Sets... \$214<sup>95</sup>

CONNECTS WITH

CONNECTS WITH

## Sponge Forceps, Single-Use

NON-STERILE **Single-Use** 

Not made with natural rubber latex.

Length: 24cm

REF 3207 12-Pack..... **\$47<sup>95</sup>**

REF 3214 24-Pack ..... **\$87<sup>95</sup>**

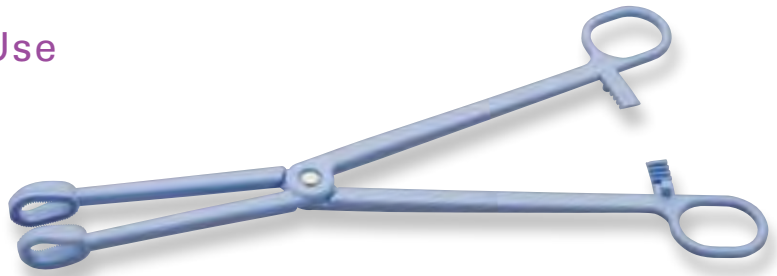

## Topical Anesthetic

### HurriCaine® Topical Anesthetic Spray Kit

2oz Spray Container

- Provides 200 one second applications
- Includes 200 Single-Use extension tubes

See product details from manufacturer.

Beutlich® Pharmaceuticals, LLC

REF 0183 ..... **\$79<sup>95</sup>**



# SHOP ONLINE

SCAN QR-CODE TO VISIT WEBSITE

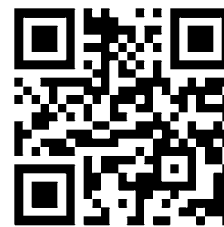

# LLETZ Instruments

## LLETZ-Coated Tenaculum

Coated Stainless Steel

**Length:** 25cm

### Braun LiteTouch™ Tenaculum

Atraumatic design

Closed position, tips overlap 1-2 mm

REF LT2250 ..... **\$159<sup>95</sup>**

### Braun Standard Tenaculum

Tips overlap 4-6 mm. ±1 mm

REF 3249 ..... **\$159<sup>95</sup>**

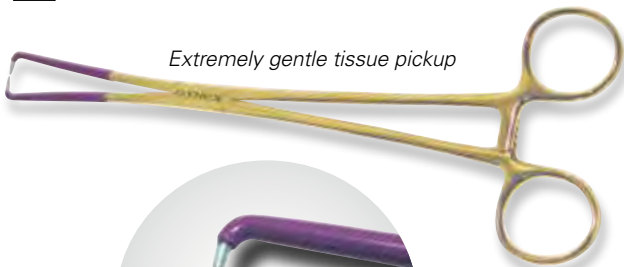

## LLETZ-Coated Hooks

Coated Stainless Steel

**Length:** 26cm on all hooks

### Iris Hook

REF 3230 ..... **\$99<sup>95</sup>**

### Emmett Tenaculum

REF 3240 ..... **\$99<sup>95</sup>**

### Angle Hook

REF 3245 ..... **\$99<sup>95</sup>**

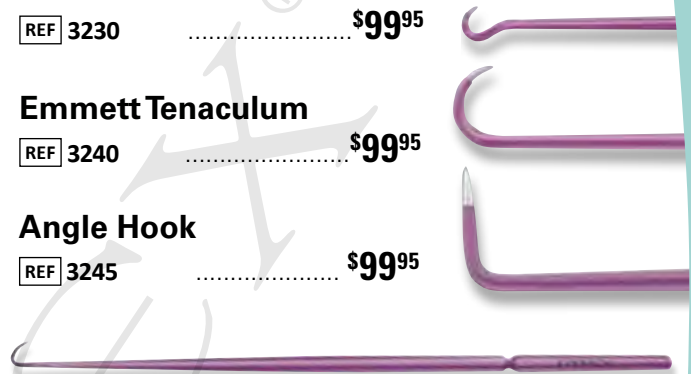

## LLETZ-Coated Rulers

### Depth Ruler

Coated Stainless Steel

- Millimeter markings, center at 5mm

**Length:** 24cm

REF 3250 ..... **\$119<sup>95</sup>**



### Width Ruler

Coated Stainless Steel

- Millimeter markings

**Length:** 22cm

REF 3255 ..... **\$119<sup>95</sup>**



## LLETZ-Coated Tissue Forceps

Coated Stainless Steel

**Length:** 21.5cm

REF 3205 ..... **\$109<sup>95</sup>**

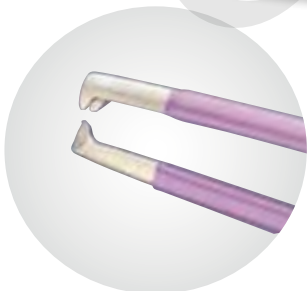

# Vaginal Speculum, LLETZ COATED

## 4-Way Expander Vaginal Speculum

The 4-Way Expander Vaginal Speculum is designed for LLETZ procedures with Gynex's lavender non-conductive coating. It provides a superior view with one instrument as compared to a standard speculum and lateral retractor. The built-in side blades are erected to enhance the view of the cervix as needed.

### Features

- Built-in smoke evacuation tube holder
- Built-in lateral retractor blades
- Side blades lock firmly into place
- Pederson size blades

### Medium

REF L4MEX 115mm..... **\$269<sup>95</sup>**

### Large

REF L4LEX 125mm ..... **\$274<sup>95</sup>**

OK to Autoclave

LLETZ Coated

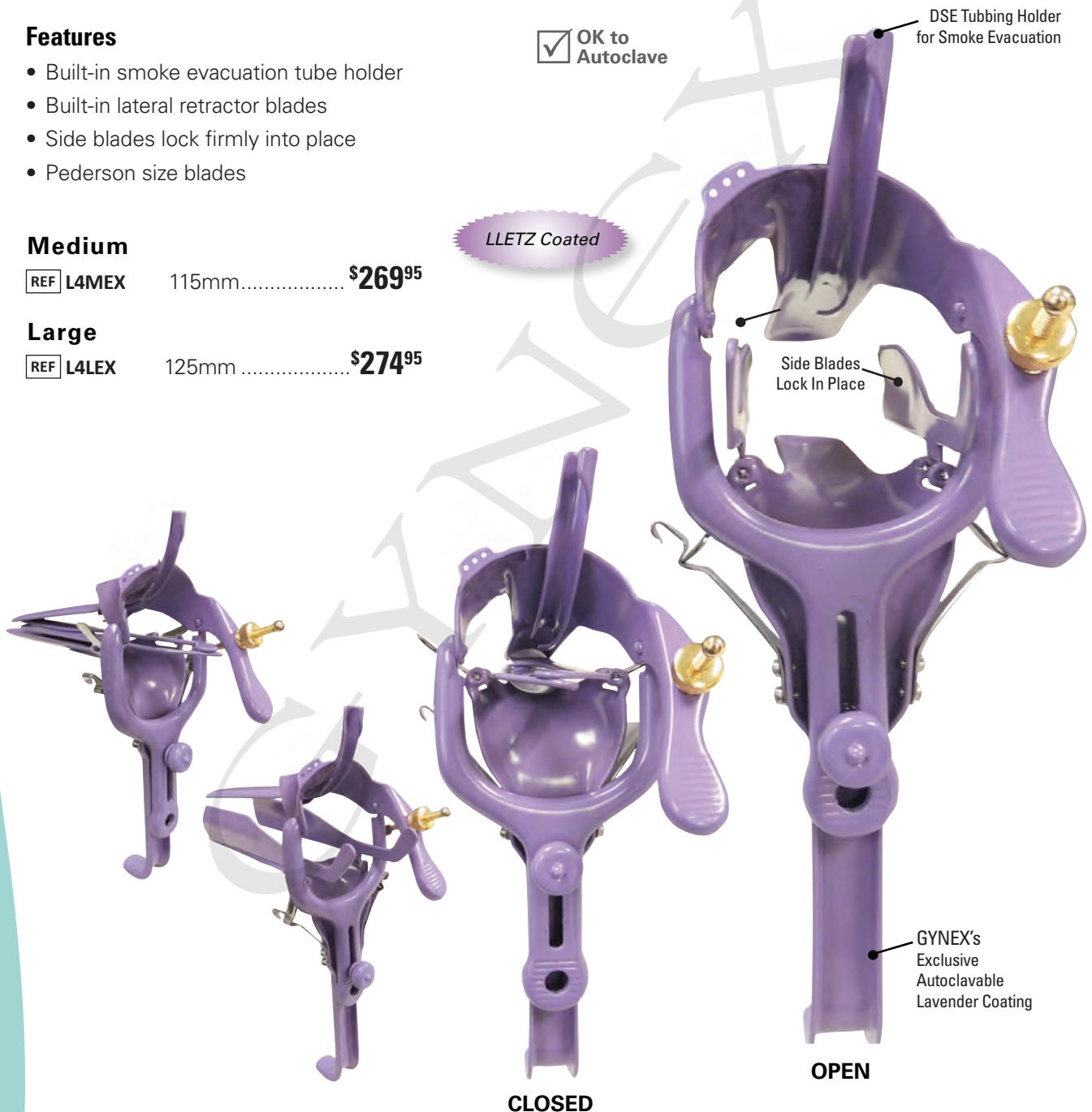

## Lateral Vaginal Retractor

Control side wall collapse during electrosurgery with a GYNEX LLETZ-Coated Lateral Vaginal Retractor. It provides the extra access and visibility needed during electrosurgery procedures of the cervix. This instrument features GYNEX's exclusive autoclavable lavender coating, providing extra durability and safety.

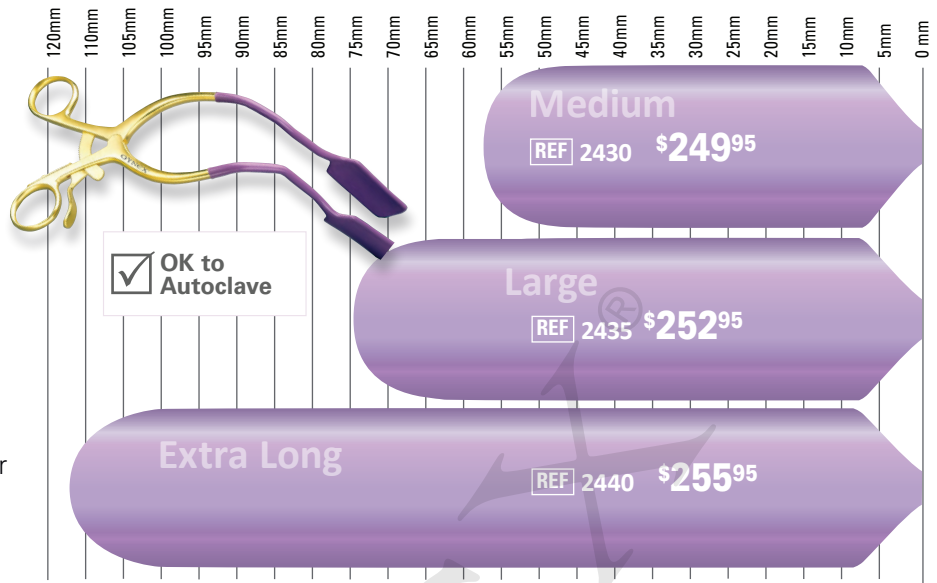

Blade Reference Chart: Shown Actual Size, Scale 1:1

## LLETZ Open-Sided Speculum

Left and Right Opening

Blade Reference Chart: Shown Actual Size, Scale 1:1

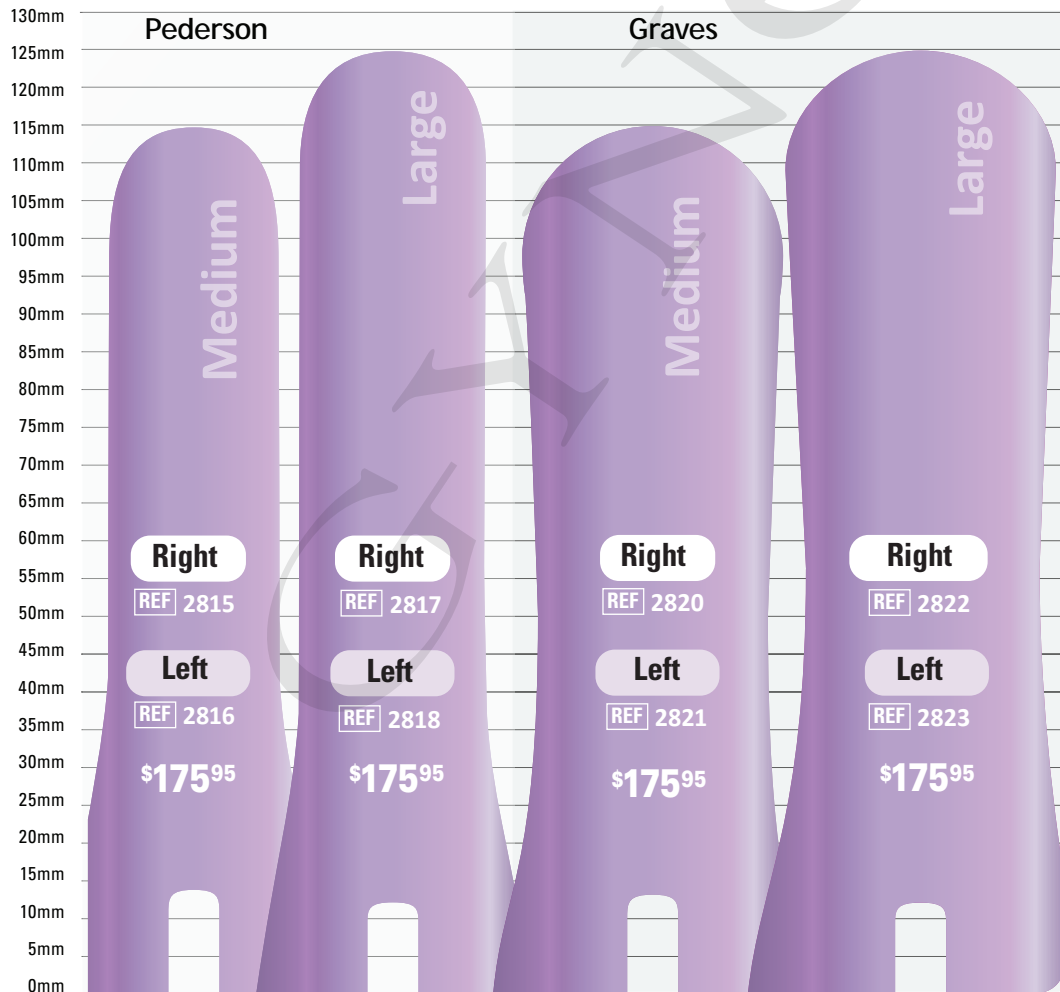

Don't Forget to Order Your DSE Smoke Evacuation Tubing for Your LLETZ Specula (see pages 72-73)

LLETZ Coated



OK to Autoclave

5% Discount on Prepaid Orders by Check or ACH payment (offer excludes microscopes, colposcopes and/or extended warranties).

# Sullivan™

VAGINAL SPECULUM

## Features

- Unique C-Arm maximizes your view
- Easy one handed open and release
- Locks firmly into place

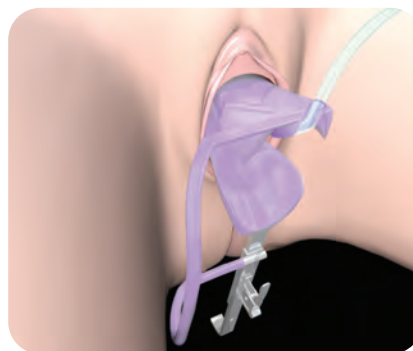

Ideal for bariatric patients

Blade Reference Chart: Shown Actual Size, Scale 1:1





*Ideal to use with  
a Lateral Vaginal  
Retractor as there are  
no side obstructions  
like most specula*

OK to  
Autoclave

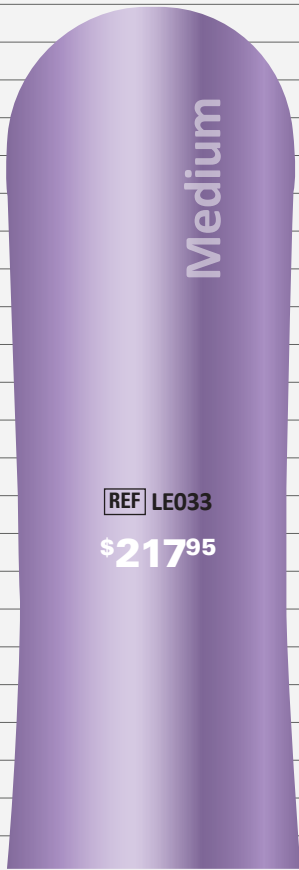

REF LE033

\$217<sup>95</sup>



# Pederson & Graves Speculum

LLETZ Coated

OK to Autoclave

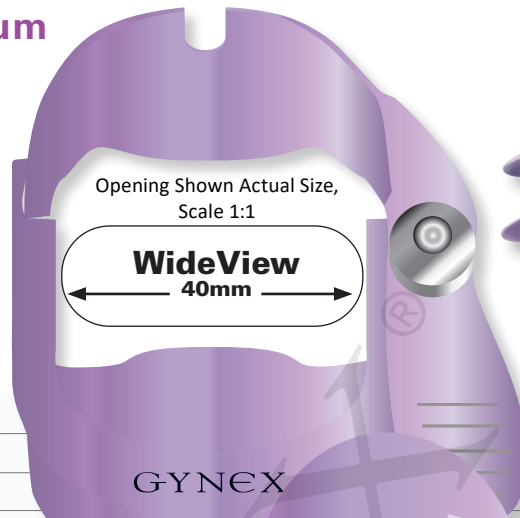

Blade Reference Chart: Shown Actual Size, Scale 1:1

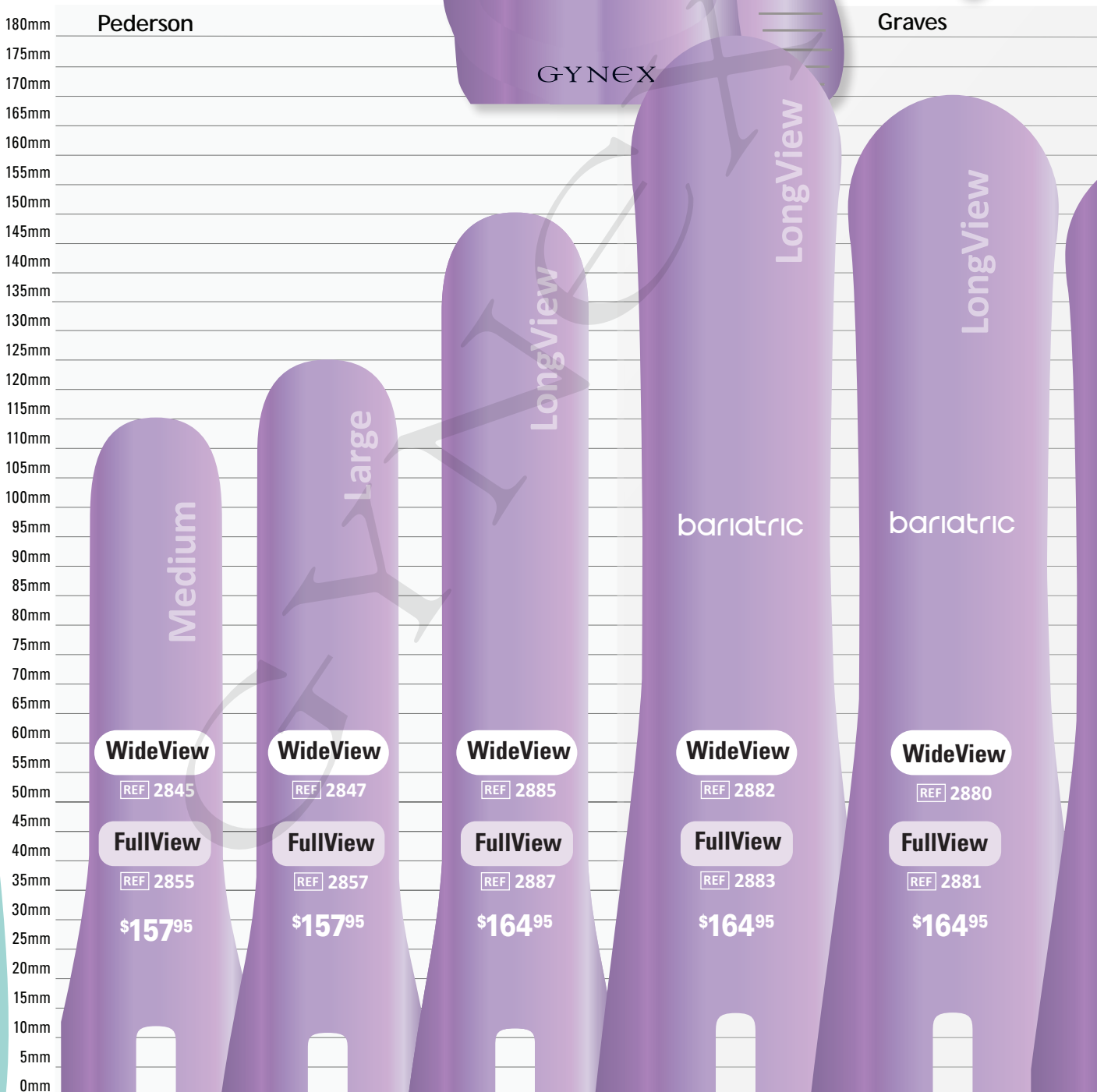

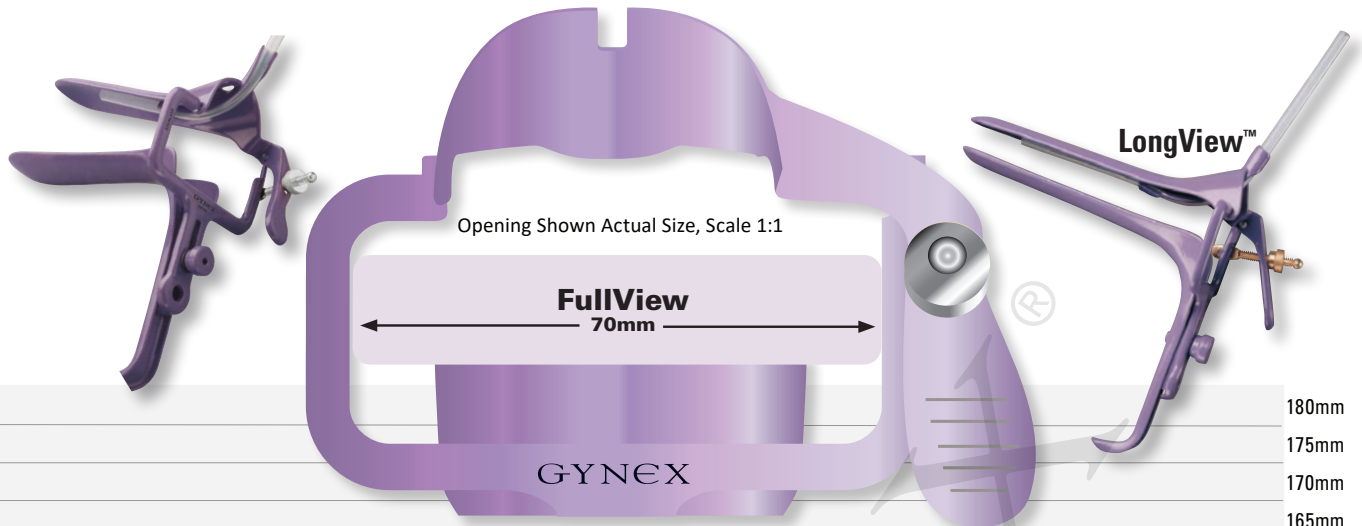

# Vaginal Speculum, STAINLESS

## Pederson & Graves Speculum

Stainless Steel

### Blade Reference Chart:

Shown Actual Size, Scale 1:1

Opening Shown Actual Size, Scale 1:1

**Standard**

← 30mm →

GYNEX

Graves

LongView

LongView

LongView

Large

Medium

Small (virginal)

bariatric

bariatric

**Standard**

REF 2457

\$34<sup>95</sup>

**Standard**

REF 2459

\$34<sup>95</sup>

**WideView**

REF 2500

\$44<sup>95</sup>

**WideView**

REF 2525

\$44<sup>95</sup>

**WideView**

REF 2785

\$62<sup>95</sup>

**WideView**

REF 2782

\$62<sup>95</sup>

**WideView**

REF 2780

\$62<sup>95</sup>

**FullView**

REF 2600

\$44<sup>95</sup>

**FullView**

REF 2625

\$44<sup>95</sup>

**FullView**

REF 2787

\$62<sup>95</sup>

**FullView**

REF 2783

\$62<sup>95</sup>

**FullView**

REF 2781

\$62<sup>95</sup>

**Small Standard\***

\*opening 25mm

REF 2455

\$34<sup>95</sup>

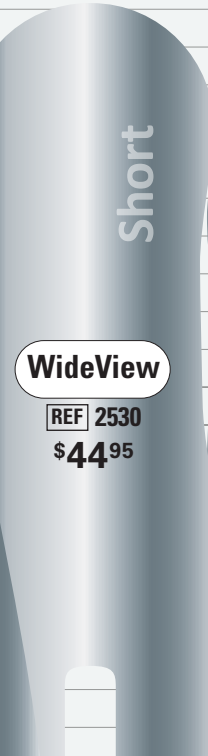
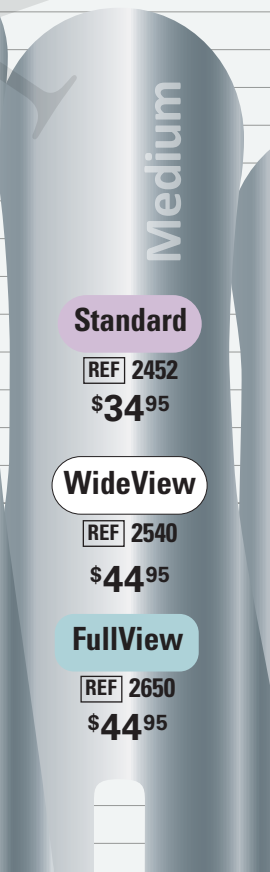
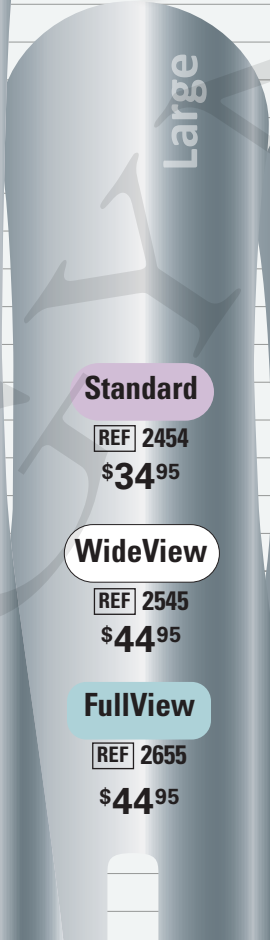
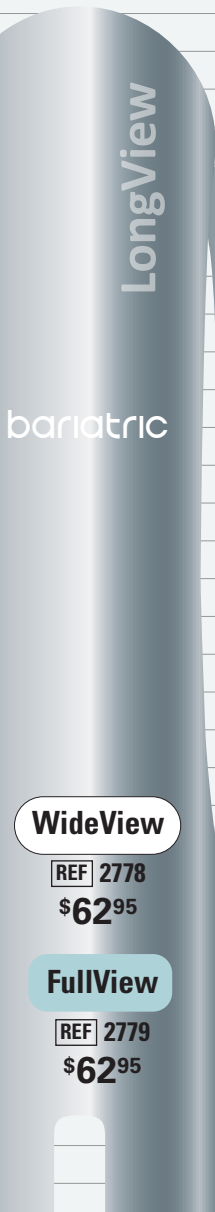
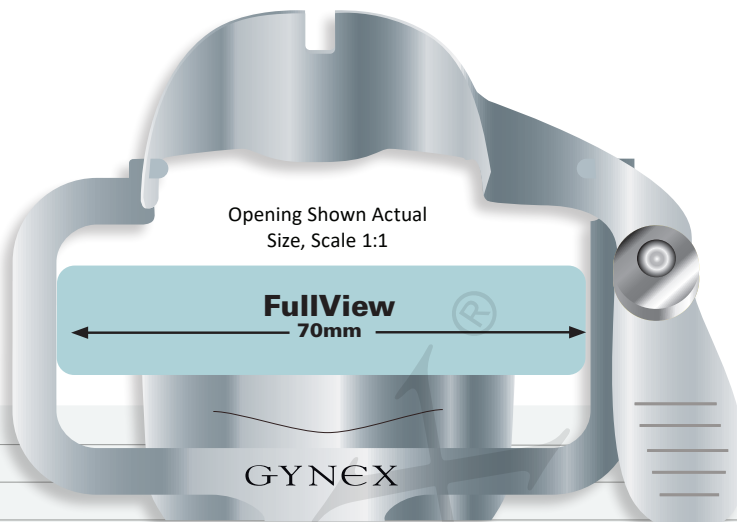
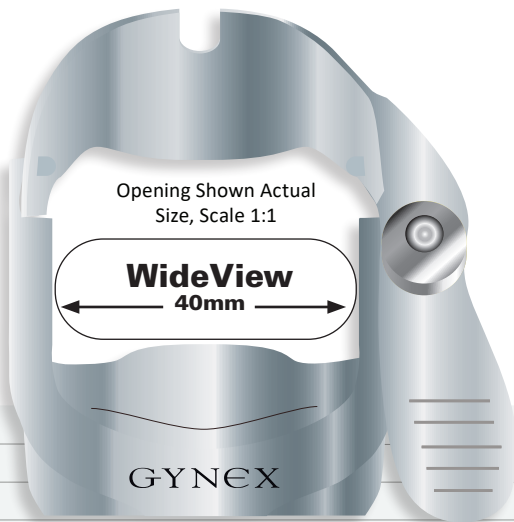

- 180mm
- 175mm
- 170mm
- 165mm
- 160mm
- 155mm
- 150mm
- 145mm
- 140mm
- 135mm
- 130mm
- 125mm
- 120mm
- 115mm
- 110mm
- 105mm
- 100mm
- 95mm
- 90mm
- 85mm
- 80mm
- 75mm
- 70mm
- 65mm
- 60mm
- 55mm
- 50mm
- 45mm
- 40mm
- 35mm
- 30mm
- 25mm
- 20mm
- 15mm
- 10mm
- 5mm
- 0mm

# Sullivan™

VAGINAL SPECULUM

## Features

- Unique C-Arm maximizes your view
- Easy one handed open and release
- Locks firmly into place

Ideal for bariatric patients

Stainless Steel



Blade Reference Chart: Shown Actual Size, Scale 1:1

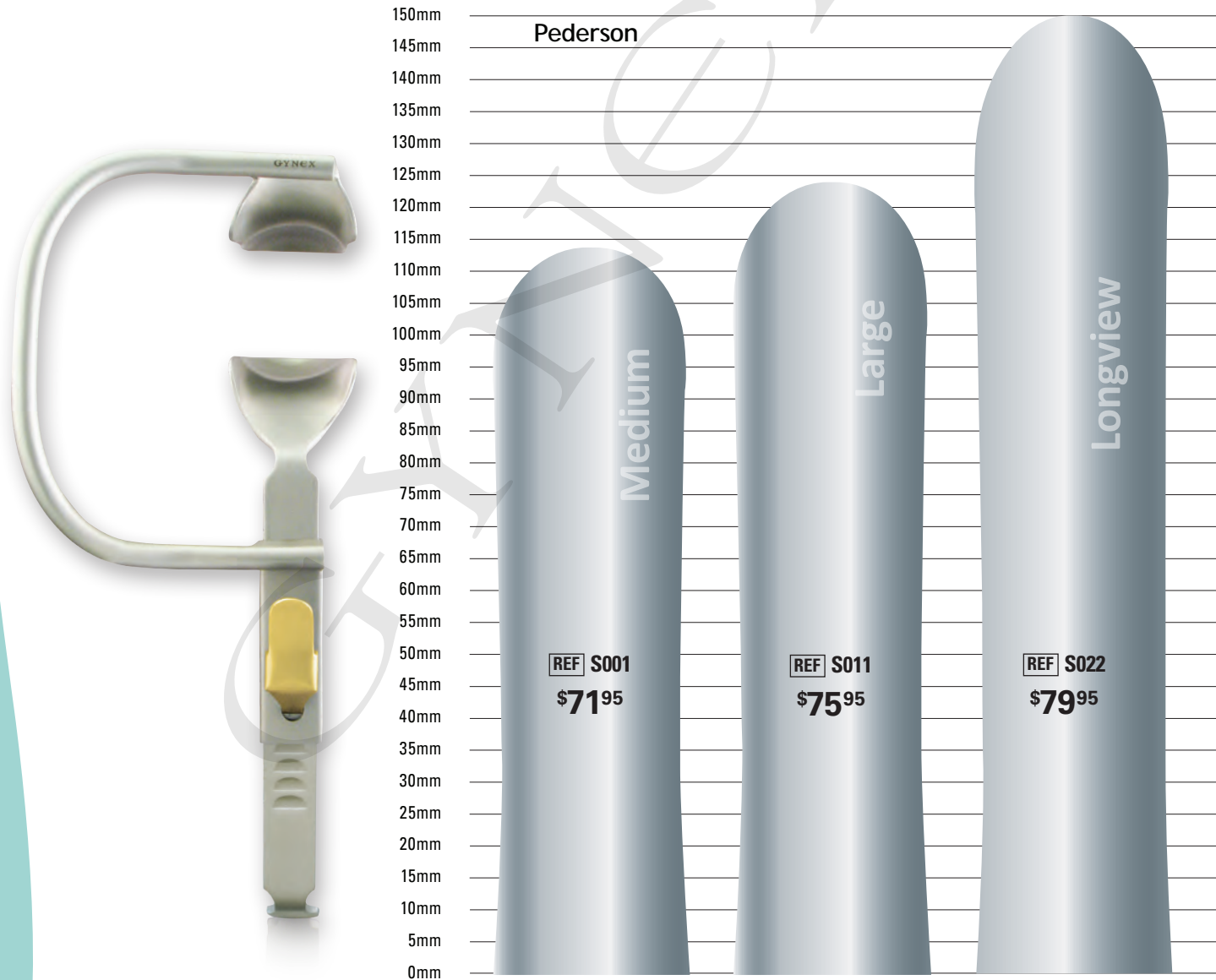

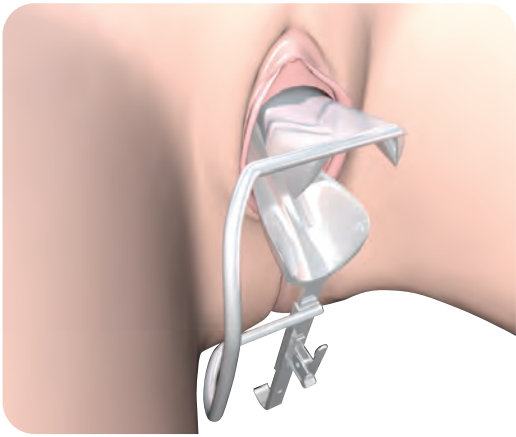

C-Arm is designed to parallel the contour of the patient's leg

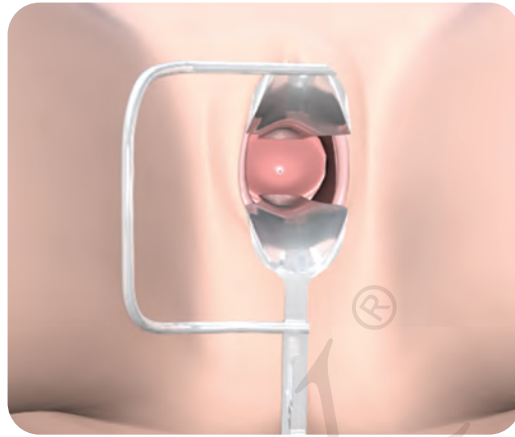

No side obstruction like most specula

Graves

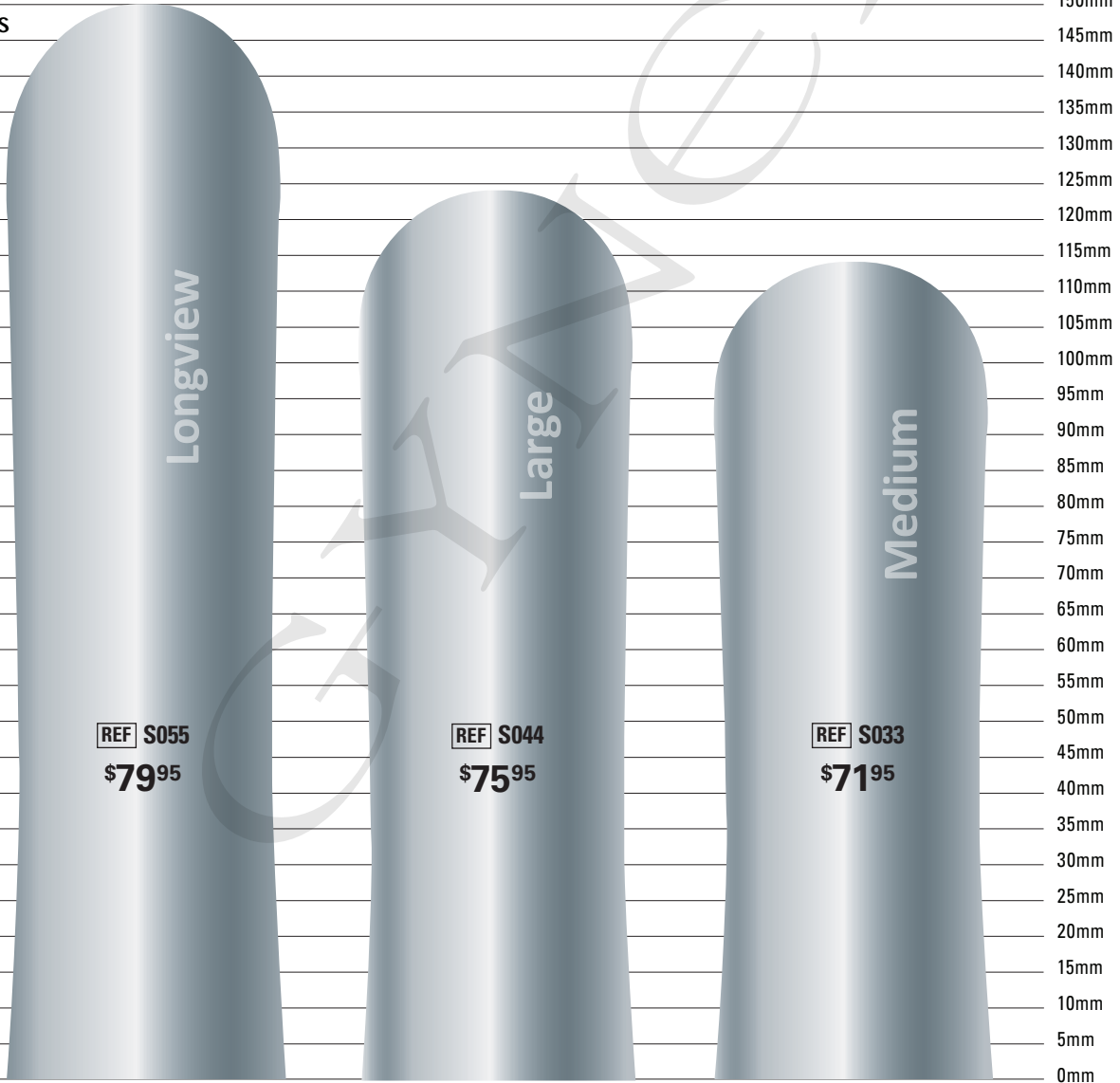

5% Discount on Prepaid Orders by Check or ACH payment (offer excludes microscopes, colposcopes and/or extended warranties).

## Lateral Vaginal Retractor

Control side wall collapse and get more cervical access with a GYNEX® Stainless Lateral Vaginal Retractor. For unparalleled ease of use and variety of practical sizes, nothing compares with GYNEX® Stainless Lateral Vaginal Retractor.

Compatible with GYNEX® Wide-View™ and FullView™ Specula

- Lateral vaginal retractors fit inside the speculum providing greater visibility and access to the cervix

Stainless Steel

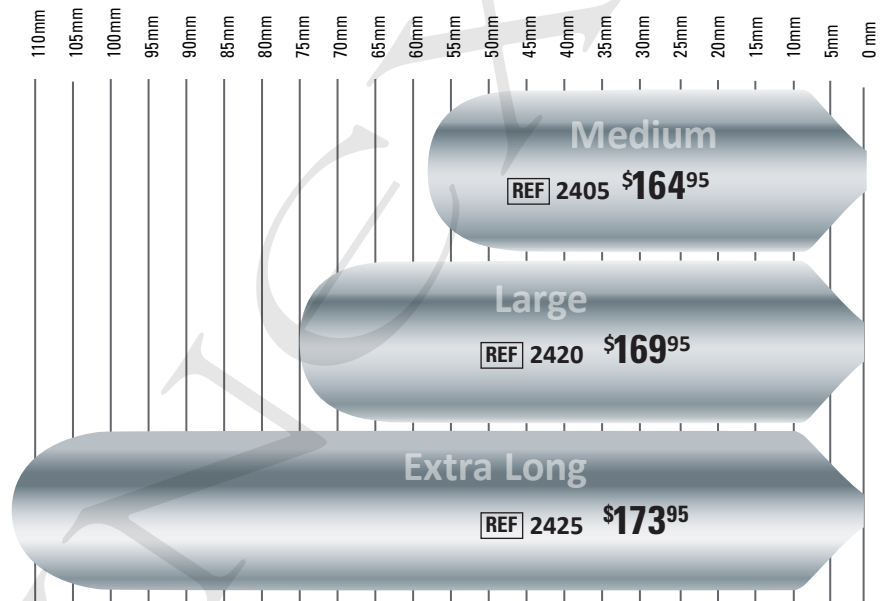
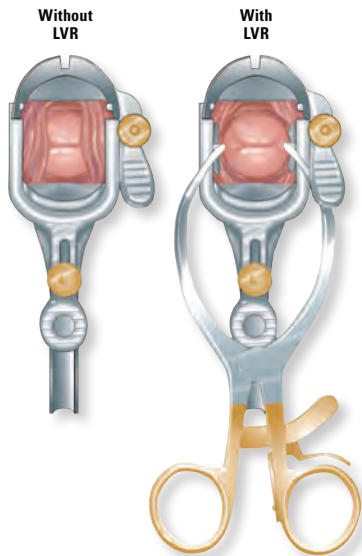

Blade Reference Chart: Shown Actual Size, Scale 1:1



## Auvard Weighted Speculum

Single-end vaginal speculum designed to be used during vaginal surgery (hysterectomy, dilation and curettage) with the patient in the lithotomy position. The weight holds the speculum in place to provide an open view.

**Fixed Weight:** 1.4 kg

**Size:** 105mm long x 38mm wide

REF SA2200 ..... \$299.95



## Guttman Speculum with Special Blades

This indispensable speculum operates without upper blades, permitting total visualization of the cervix & vagina. Two separators aid in the opening and stabilizing the vagina.

### Medium

REF 2310 Top Separator: 82mm ..... **\$69<sup>95</sup>**

### Large

REF 2312 Top Separator: 92mm..... **\$69<sup>95</sup>**



## Greenberg Hysteroscopy Speculum

The Greenberg Hysteroscopy Speculum is a modified traditional open-sided Graves speculum with shorter blades and an open side allowing removal of instruments while they are still in the vagina. This speculum brings the patient's cervix closer to the provider and reduces the length of unsupported hysteroscope shaft entering the cervical canal.

REF 2801 ..... **\$59<sup>95</sup>**



*"The shorter blades bring the external os about 30% closer to the introitus and make access to the cervix dramatically easier in almost every facet of surgical cases in which a speculum is used."*

**James Greenberg, MD,**  
Boston, MA

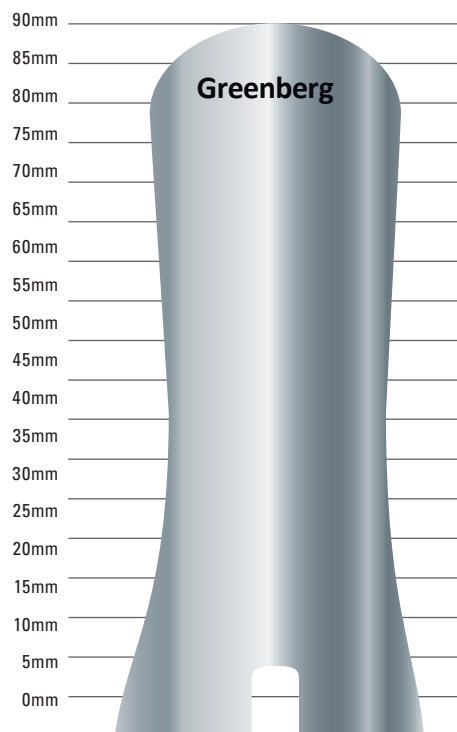

# Open-Sided Stainless Steel Speculum

Left and Right Opening

Stainless Steel

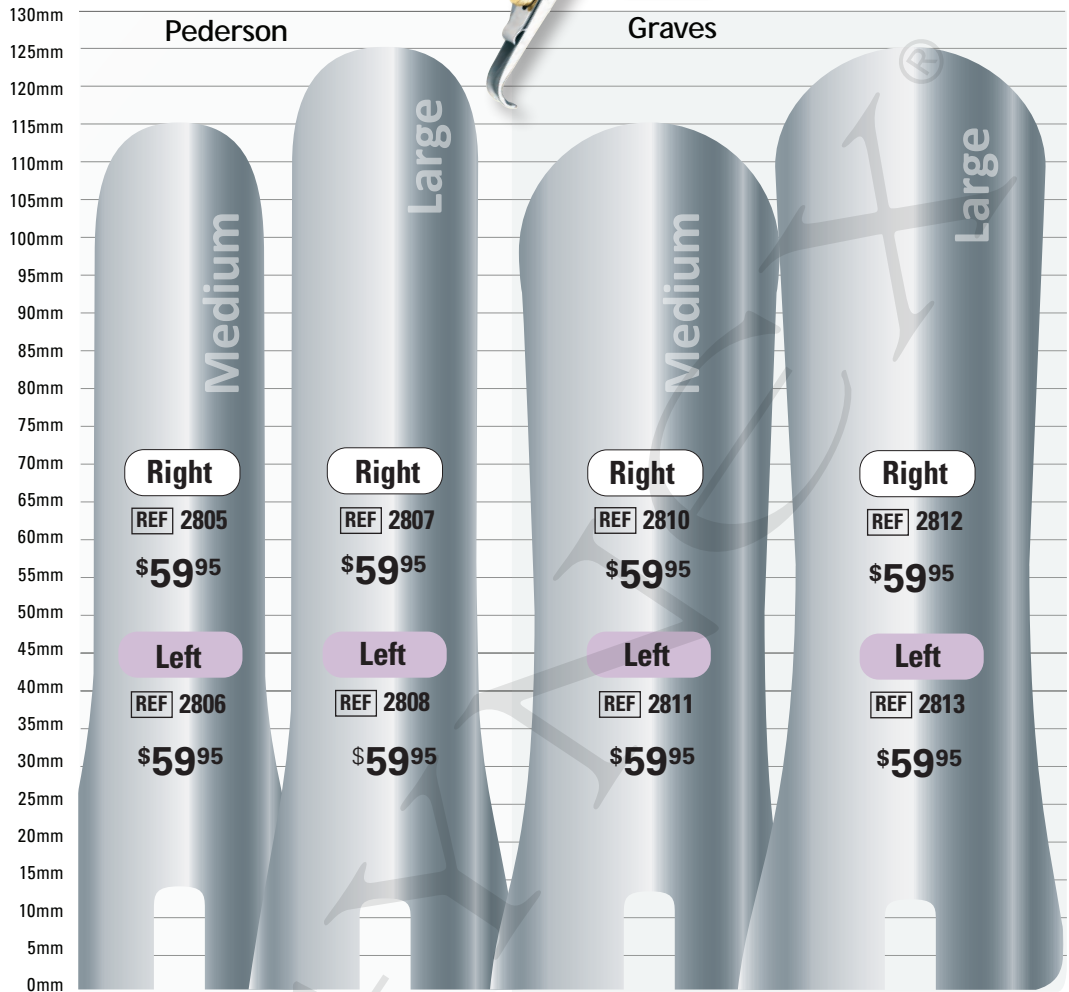
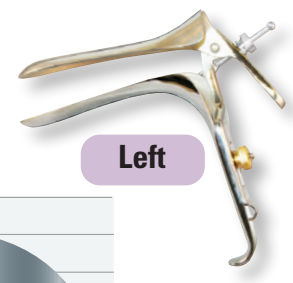

**Note:** Blade length is measured from top center of back of blade to end of distal tip. In most cases, the bottom speculum blade will protrude and appear to be longer. Mechanical assembly of a speculum simply places the bottom blade in a more forward position. Although the two blades are normally similar in length, they may vary a few millimeters from lot to lot.

# Titanium Rainbow™ Speculum

Exclusive Titanium Rainbow™ coating extends the life of instruments over traditional stainless-steel. The titanium coated speculum offers increased resistance to corrosion, resilience against impact and low friction coefficient. Titanium Rainbow™ is available in two viewing widths for Pederson and Graves.

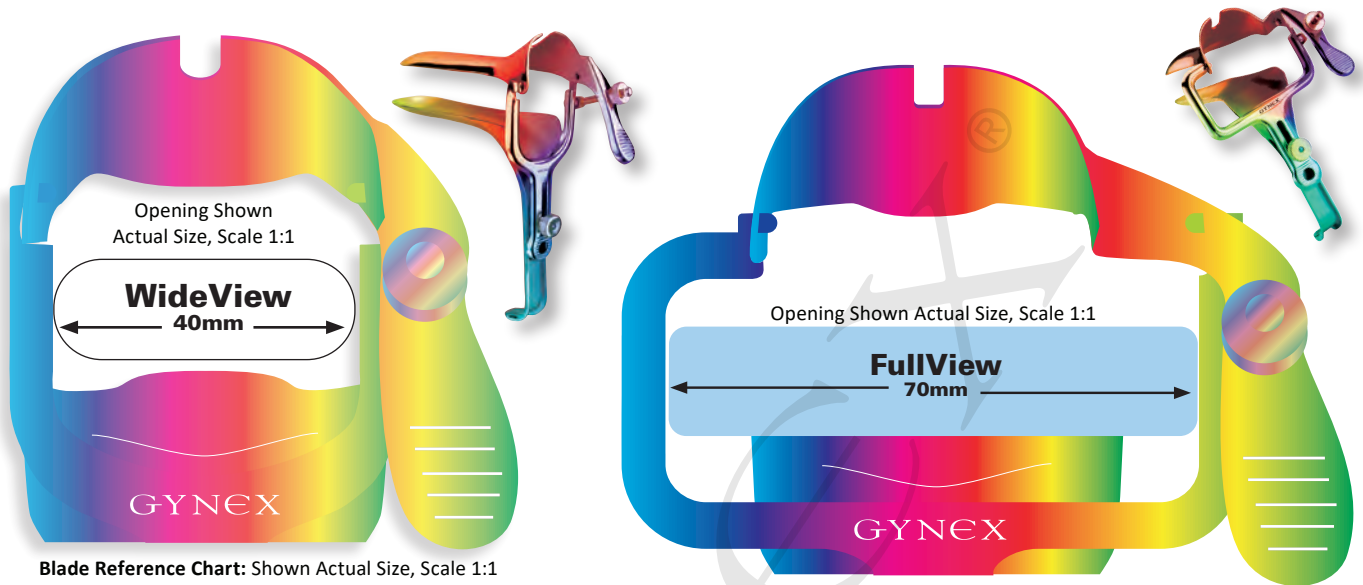

Blade Reference Chart: Shown Actual Size, Scale 1:1

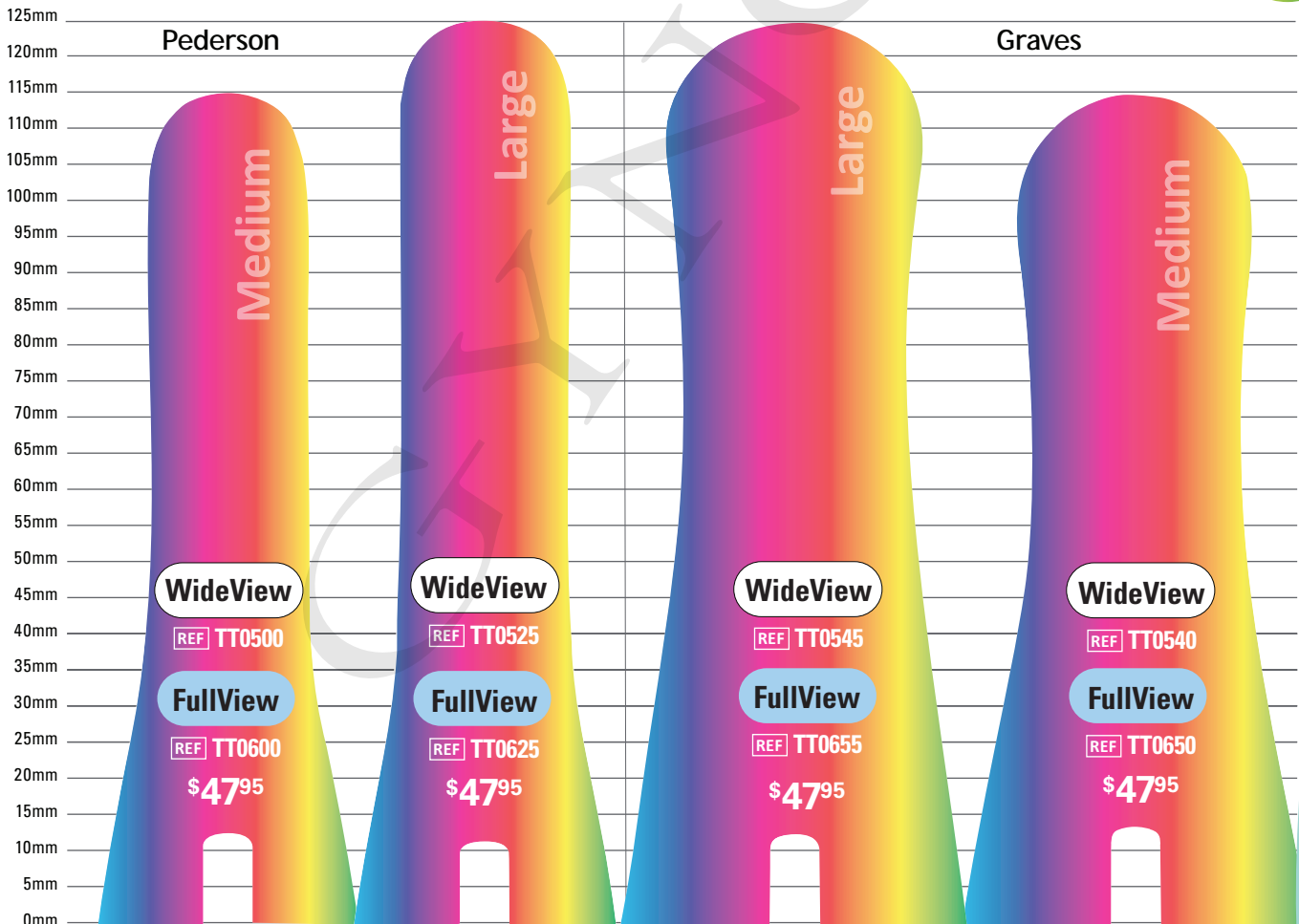

5% Discount on Prepaid Orders by Check or ACH payment (offer excludes microscopes, colposcopes and/or extended warranties).

# GYNEX® ULTRASONIC FETAL DOPPLER

New

Add this excellent Fetal Doppler to your practice!

## Fetal Doppler Model D2500

- Highly sensitive ultrasound
- Detects heart rates of fetus as early as the 12th week
- Automatic shutdown after 1 minute without operation
- Built-in loudspeaker
- Rechargeable battery, 1180 mah lithium
- Colorful display
- 2.5MHz Ultrasound Frequency
- FHR value, FHR waveform volume
- Includes battery charger and earphones

**Dimension:** 215mm x 200mm x 66mm

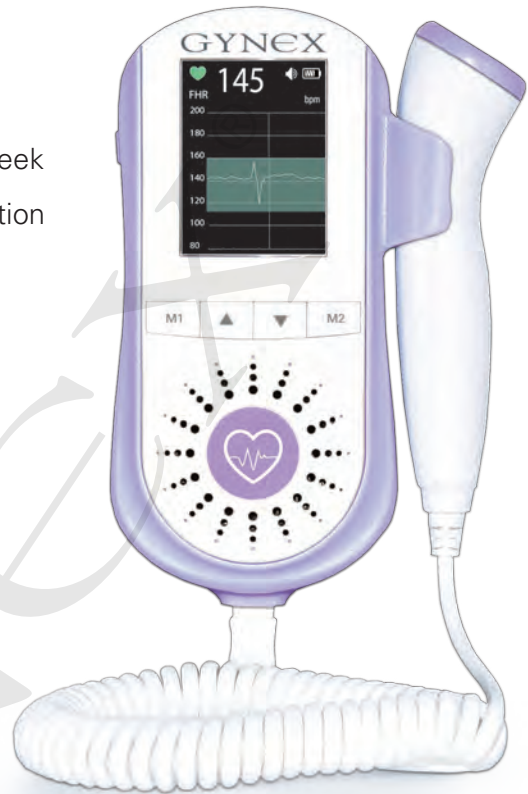

REF D2500 ..... **\$334<sup>95</sup>**

## Thermasonic Gel Warmer

- Maintains constant temperature
- Low electrical demand
- Heat indicator lamp
- Adjustable thermostat

REF D82-01 ..... **\$314<sup>95</sup>**



## Doppler Gel

- Acoustically correct for the broad range of frequencies used
- Completely aqueous, will not stain clothing or damage transducers
- 250ml bottle

REF D-GEL Box of 6 ... **\$40<sup>95</sup>**



# pHem-Alert® Vaginal pH Test

NON-STERILE Single-Use

Not made with natural rubber latex.

pHem-Alert® test measures vaginal pH, and is intended for use by women who have any of the following vaginal symptoms: Itching, Burning, Unpleasant Odor, Unusual Discharge

## KEY ADVANTAGES

- Each test securely packed in a procedure blister tray
- Convenient, unique, patented applicator “key” with attached pH paper
- Easy to read pH chart included with every test set

REF pH-99 Box of 12 ..... \$69<sup>95</sup>



*The Original Vaginal pH Test Designed for Accurate & Comprehensive Results!*

- pH 4.5**
  - Normal pH
  - Predominant lactobacilli
  - Possible yeast overgrowth
  - Normal serum estradiol
- pH 5.0**
  - Low grade bacterial vaginitis
  - Borderline serum estradiol
- pH 5.5**
  - Bacterial vaginitis
  - Low serum estradiol
- pH 6.0**
  - Bacterial vaginitis
  - Low serum estradiol
- pH 6.5**
  - Bacterial vaginitis
  - Very low serum estradiol
- pH 7.0**
  - Low to no serum estradiol
- pH 7.5**
  - Low to no serum estradiol

# Instrument Care and Cleaning

## Touch-Guard® Hot Beads

### Sterilization Beads

- Touch-Guard® Hot Beads provide a safe, effective and convenient way to sterilize surgical instruments.
- No need for potentially dangerous gases, flames, or chemicals to achieve sterilization.
- The specially cast “no-lead” glass beads transmit heat properly and remain intact at high temperatures.
- Simply plunge metal instruments into the hot glass beads for instant sterilization.
- Touch-Guard® Hot Beads are free of pathogens and microbial contaminants.
- Pre-measured containers make it easy to use the right amount of beads for each sterilization cycle.



SCAN to SHOP



REF 7106 6-Pack (6-month supply) ..... **\$139<sup>95</sup>**

REF 7112 12-Pack (1-year supply) ..... **\$257<sup>95</sup>**

## Touch-Guard® Stain-Ex™

### Biological & Chemical Stain Remover

- Touch-Guard® Stain-Ex™ is a fast and effective biological and chemical stain remover.
- It removes a variety of stains, including Iodine-based stains, Lugol's stain, and medical/histological stains.
- It can be used on a range of surfaces, including hands, glassware, stainless steel, plastic, counters, floors, lab coats, laboratory equipment, and hospital linen.
- Touch-Guard® Stain-Ex™ works great on LLETZ-coated instruments.
- Application is easy, and stains are removed quickly (in a matter of seconds).

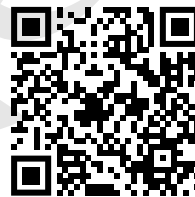

SCAN to SHOP



REF SS10 1 Gallon ..... **\$94<sup>95</sup>**

## Touch-Guard® Low Suds

### Liquid Instrument Detergent Concentrate

Touch-Guard® Low Suds Liquid Instrument Detergent Concentrate is used for effectively and safely cleaning all surgical instruments, plastic, glassware, and rubber tubing. Formulated for use in automatic washers, ultrasonics, washer-sterilizers, and manual cleaning.

- Neutral pH detergent with powerful sequestering and emulsifying agents
- Fast wetting, odorless, non-sudsing, maintains high detergency
- Removes protein, blood, tissue, fat and any organic soils
- No residue - no pyrogens; leaves a surgically clean surface
- Exceptional cleaning in hard, soft, cold or hot water
- Biodegradable; contains no phosphates or NTA
- Free rinsing, non-enzymatic formulation
- Safe for ophthalmic cleaning



SCAN to SHOP



REF TG-200 1 Gallon ..... **\$34<sup>95</sup>**

## Touch-Guard® Lubricant

### Instrument Lubricant and Rust Inhibitor

Touch-Guard® Instrument Lubricant and Rust Inhibitor protects and extends the life of all your surgical instruments. Clinically tested to be thoroughly steam penetrable, steam sterilizable and ETO sterilizable. When used daily as a rinse after cleaning, it will keep your instruments moving parts operating smoothly and remain effective even after autoclaving, without any oily residue.

- Reduces repair and replacement cost
- Prevents rust, spots, stains and corrosion
- Restores articulation to sticky box-locks and joints
- Withstands high temperatures and autoclaving
- Steam penetrable, sterilizable and ETO sterilizable
- Non-oily, non sticky, non-toxic, water-soluble and silicone free

REF TG-100 16.9 fl. oz. (500 ml) ..... **\$19<sup>95</sup>**



SCAN to SHOP

**FREE  
SAMPLE**

To redeem your free sample,  
contact us  
**(888) 486-4644**



## Instrument Repair and Sharpening

Gynex® allows you to extend the life of your instruments, deliver optimal performance and better manage your surgical asset investment. All sharpening and repairs also include rust/stain removal, cleaning, minor polishing and lubrication.

Gynex® sharpens and repairs most medical instruments. If the instrument that you would like to have sharpened or repaired is not listed here, or you have any questions, please contact us for more information.

Please note that due to metal, age and condition, some instruments may not be repairable or sharpened.

### Pricing is as follows:

Gynex® Biopsy Punch .....	<b>\$65<sup>00</sup></b>
Other Brand Biopsy Punch .....	<b>\$75<sup>00</sup></b>
Gynex® Curette .....	<b>\$40<sup>00</sup></b>
Other Brand Curette .....	<b>\$50<sup>00</sup></b>

**Toll Free: (888) 486-4644**  
(8:00AM–5:30PM CDT)

### **Selling Notice:**

All products are limited to purchase by licensed medical practitioners, physician and medical facilities. In most cases, we do not sell to the general public.

### **Warranty:**

All hand-held instruments in this catalog are warranted to be free of defects in manufacturing materials and workmanship for two years from date of purchase. Customers who feel an instrument is defective must return it to GYNEX for evaluation. Products found to be defective will either be repaired or replaced with the same or comparable product, at the discretion of GYNEX Customer Service. Warranty on any hand-held GYNEX instrument is voided if instrument is repaired or sharpened by anyone other than GYNEX. All GYNEX biopsy punches in this catalog will be sharpened free of charge for one year from date of purchase (if enough metal is remaining on tip to allow sharpening). Warranties do not cover general maintenance, cleaning or sharpening needs that result from normal use, except as noted above regarding biopsy punch sharpening. Damages caused by misuse, improper care, cleaning, chemicals, or loss and theft are not covered by this warranty. Shipping charges are not covered for free sharpening warranty nor extended equipment warranty.

### **Return Policy:**

Customer must obtain a Returned Merchandise Authorization (RMA) number from GYNEX customer service at (888) 486-4644. An itemized list of returned products must accompany all returns. Include the Returned Merchandise Authorization (RMA) number and explanation of why the product is being returned. Returned goods MUST be packaged in a shipping container equivalent to that in which it was received. Returned goods MUST be shipped at customer's expense by Parcel Post, Airborne, FedEx or UPS, and must be insured for the purchase price of the contents. Returned goods received by GYNEX in any form less than that described above

will be refused by GYNEX and return shipped to the customer.

### **The following items may be returned:**

- Product with RMA number
- All returns must be made within 30 days of the item receipt (except for warranty).
- Product with unbroken seals, with labels intact, in original container and packaging
- Unused instruments which have not been cleaned or sterilized
- Single-Use<sup>®</sup> product (sterile) in original, unopened package
- Product damaged in shipment\*
- Product that has at least 12 months remaining shelf life as determined by the expiration date
- Instruments damaged, broken or not working properly due to defects in material or workmanship

*\*Note: Product returned due to error or damage in shipping must be reported to customer service within 72 hours of receipt. Damaged product must be accompanied by a written explanation noting damage.*

### **The following items may not be returned:**

- Product without RMA number
- Product that has been improperly handled or stored
- Product that is marked, coded, dated, damaged, soiled or adulterated in any way (except standard cleaning and sterilization procedures for reusable instruments)
- Product damaged by or exposed to heat, fire, smoke, high humidity or water (except standard cleaning and sterilization procedures for reusable instruments)

### **Restocking Charge:**

A 15% restocking charge applies to all returned product, unless the return is due to error in shipment, product damaged in shipment, or product returned for repair or replacement due to defect in material or workmanship.

### **Disclaimer:**

All prices in this catalog are subject to change without notice. All sizes indicated may vary slightly, due to differences between manufactur-

ers. In order to carry sufficient inventory, it is necessary for GYNEX to purchase from different manufacturers. As a result, final products may not be the exact sizes as shown in charts, drawings or photos. The advertisements and information in this catalog may contain typographical errors or inaccuracies and may not be complete or current. GYNEX therefore reserves the right to correct any errors, inaccuracies, or omissions and change or update information at any time without prior notice. Please note that such errors, inaccuracies, or omissions may relate to pricing or availability. We reserve the right to refuse to honor offers or terms, which contain error or inaccuracies.

### **Trademark Notices:**

Apex, Ascona, Ceramix, Century Uterine Manipulator/Injector, Clear-Flue, C-Safe, Direct-Access, EasyView, HexLoc, i-Series Titanium Rainbow, LiteTouch, LongView, FullView, LVR, NoSlip, New GYNeration, Opal Rainbow, Reach, Reach Extended Needle, RotoTip, Stain-Ex, Titanium Rainbow, TouchGuard, Villa, WideView, Willows and Zephyr are trademarks of GYNEX Corporation. Dennis Dilators and Galileo are registered trademarks of GYNEX Corporation. Use of these product names is limited to those with written authorization by an officer of GYNEX Corporation of North Richland Hills, Texas. ConMed and Sabre are registered trademarks of ConMed, Inc. UMI is a trademark of Thomas Medical, Inc. CooperSurgical, Shur-Lock and Euro-Med are registered trademarks of Cooper Companies. HurriCaine is a registered trademark and Snap -n- Go is a trademark of Beutlich LP, Pharmaceuticals. pHem-Alert is registered trademark of FemTek, LLC. Suresample is a registered trademark, and Portex is a trademark of Smiths Group. Z-Sampler is a trademark of BEI Medical Systems Company Inc. BEI is a registered trademark of BEI Medical Systems Company Inc. Pipelle is a registered trademark of Unimar, Inc. Utah Medical Products and Finesse are registered trademarks of Utah

Medical Products, Inc. Endocell is a trademark of Wallach Surgical Devices, Inc., and Wallach is a registered trademark of Wallach Surgical Devices, Inc. Teflon is a registered trademark of DuPont.

### **Force Majeure:**

Neither party shall be liable for any failure or delay in delivery of goods, or in otherwise fulfilling its obligations with respect to the sale of goods to the other which results from any cause beyond its reasonable control, including disruption or delays in a common carrier's transportation schedule, compliance with any regulations, orders, acts, instructions, or priority requests of any national, state or municipal government, or any department or agency thereof, or from acts of God, fires, or other casualty of accidents, strikes, lockouts, factory shutdowns, embargoes, riots, or other disorders, delays or shortages in transportation, or inability to obtain in sufficient quantity fuel, power, labor, manufacturing facilities or materials or other supplies from the usual sources of GYNEX. Notwithstanding the foregoing, in the event a party is unable to perform as a result of such force majeure event for a period exceeding sixty (60) days, the other party may, at its option, terminate its purchase order or commitment to sell the goods and neither party shall have any further liability hereunder other than for past services rendered and goods sold.

### **Official Notice**

**ALL products are shipped from GYNEX state-of-the-art warehouse in North Richland Hills, Texas**



# INDEX

<b>ACETIC ACID</b> .....	5	<b>ENDOCERVICAL</b>		<b>OVUM FORCEPS</b>	
Alligator Grasper, Gynex®.....	28	Curettes - Rainbow™ and Stainless.....	18	Bierer.....	21
Ascona™ IUD String Snare.....	30	Kevorkian Curette, Single-Use.....	19	Blumenthal.....	21
Accu-Sound®.....	31	Lickerish Spiral Curettes.....	19	Jacobson.....	21
<b>BARIATRIC INSTRUMENTS</b>		RotoCurette™.....	19	Saenger.....	21
Biopsy Punches.....	6-14	Specula.....	16	Sopher Original.....	20
Tissue Forceps.....	16	<b>ENDOMETRIAL CURETTE AND SAMPLER</b>		<b>PATEL™ MULTI-USE FORCEPS</b> .....	4, 24
Specula, LLETZ Coated.....	80-81	Navak and Randall Curette (Stainless).....	17	<b>PUNCHES</b>	
Specula, Stainless Steel.....	82-83	SURESAMPLE® <i>Select1</i> Curette.....	42-43	Keyes Vulvar.....	23
<b>BIOPSY PUNCHES</b>		SURESAMPLE® Sampler.....	44-45	Keyes Accessories.....	23
Amethyst.....	8	<b>FORCEPS</b>		<b>REPAIRS &amp; SHARPENING SERVICE</b> .....	93
Apex™.....	14	Corson Myoma Polyp Grasping Forceps.....	22	<b>SCISSORS</b>	
Ceramik™.....	6	Foerster Forceps, Stainless Steel.....	16	IUD String.....	25
Gold.....	9	Laminaria Insertion Forceps.....	64	Titanium Rainbow™.....	63
Kevorkian Ring Handle.....	14	Sponge Forceps, Single-Use.....	74	Zephyr™ Stainless Steel.....	63
Medium-Tischler.....	11	Ovum Forceps.....	20-21	Iris Stainless Steel.....	64
Mini-Tischler.....	10	Bozeman Uterine Forceps.....	2, 70	Littaur Stitch Scissors.....	64
Opal Rainbow™.....	7	<b>FETAL DOPPLER - GYNEX®</b> .....	90	Metzenbaum TC Scissors.....	3
Rose Gold.....	9	<b>GRASPER</b>		<b>SMOKE EVACUATION</b>	
Sapphire.....	8	Alligator Grasper - GYNEX®.....	28	Prefilter, Single-Use ☉.....	72
ROTOTip™ Biopsy Punches.....	12-13	Serpentine Grasper.....	28	Prefilter Reducer.....	72
Sullivan Ring Handle.....	14	<b>HOOKS</b>		ULPA Filter.....	72
<b>BOZEMAN UTERINE FORCEPS</b> .....	2, 70	LLETZ Coated.....	75	Tubing.....	73
<b>CARE AND CLEANING</b>		Stainless Steel.....	17	<b>SPECULA</b>	
Hot Glass Beads Sterilizer - Touch-Guard®.....	92	<b>IUD INSTRUMENTS</b>		<b>LLETZ Coated</b>	
Instrument Lubrication - Touch-Guard®.....	93	Ascona™ IUD String Snare.....	30	4-Way Expander.....	76
Instrument Repair and Sharpening.....	93	Ceramik™ Coated String Scissors.....	25	Graves.....	80-81
Low Suds Detergent - Touch-Guard®.....	92	Crochet Type IUD Removers.....	29	Open-Sided (left/right opening).....	77
Stain-Ex™ Stain Remover - Touch-Guard®.....	92	GYNEX® Alligator Grasper.....	28	Pedersons.....	80
<b>COLOSCOPES</b>		IUD Insertion Kit, Single-Use - GYNEX®.....	30	Sullivan.....	78-79
Galileo®.....	46-51	IUD String Scissors.....	25	<b>Stainless Steel</b>	
Accessories for Galileo®.....	52	Serpentine Grasper IUD Remover.....	28	4-Way Expander Vaginal Speculum.....	2
CO Series.....	54-59	Single-Use IUD String Scissors.....	28	Auvard.....	86
<b>DILATORS</b>		Villa™ Hormonal Dissecting Forceps.....	26	Graves.....	82-83
All Uterine Dilators.....	33-39	Villa™ Hormonal Implant Remover.....	27	Greenberg.....	87
Dennis Dilators, Single-Use ☉.....	38	Willows™ IUD String Snare, Single-Use.....	29	Guttman.....	87
Dennis Dilators, Reusable.....	39	<b>LATERAL VAGINAL RETRACTORS</b>		Open-Sided (left/right opening).....	88
Hank Dilators, Uterine.....	34	LLETZ.....	77	Pederson.....	82
Hegar Dilators, Uterine.....	35	Stainless Steel.....	86	Sullivan.....	84-85
Mini Dilators, Uterine.....	33	<b>LLETZ COATED INSTRUMENTS</b>		<b>Titanium Rainbow™</b>	
Mini Dilators Tips, 4mm and 5mm.....	33	All Items.....	75-81	Graves.....	89
Pratt Dilators, Uterine.....	35	Hooks.....	75	Pederson.....	89
Small Dilators, Uterine.....	34	LVR.....	77	<b>TABLE OF CONTENTS</b> .....	1
Soft Dilators, Single-Use ☉.....	36	Speculum.....	77-81	<b>TENACULA</b>	
Soft Teflon Dilators, Reusable.....	37	Sponge Forceps, Single-Use ☉.....	74	Braun.....	15
Doppler Gel.....	90	<b>MEDICAL EXAM LIGHT - Galileo®</b> .....	60-61	Schroeder.....	15
<b>ELECTRODES</b>		Medical Exam Light - Accessories.....	60	Skene.....	16
Ball Electrode.....	67	Medical Exam Light Protective Sheath.....	61	Teale.....	16
Contoured Loop Electrodes.....	68	Microscope - Galileo®.....	53	<b>TISSUE FORCEPS</b> .....	16
Electrode Extender.....	65	<b>METZENBAUM TC SCISSORS</b> .....	3	<b>TOPICAL ANESTHETIC - HurriCaine®</b>	
Electrode Handpieces.....	65	<b>MONSEL'S PASTE</b> .....	5	Spray Kit.....	74
H-Series Loop Electrodes.....	67	<b>NEEDLE ADAPTER</b> .....	71	<b>TRANSIT MAP</b> .....	96
Needle Electrode.....	67	<b>NEEDLE HOLDERS</b>		<b>UTERINE MANIPULATOR / INJECTOR - CenturyUMI™</b>	41
Radius Loop Electrode.....	66	Webster.....	64	<b>UTERINE SOUNDS</b>	
Triangle Loop Electrodes.....	68	Mayo-Hegar.....	64	Accu-Sound®.....	31
Square Loop Electrodes.....	67	Crile-Wood.....	64	Sim Sound.....	32
Electrosurgical Patient Dispersive Pads.....	69			Sim Sound • flex.....	32

# Transit Map

## Shipping from:

6631 Browning Drive,  
North Richland Hills, TX 76180

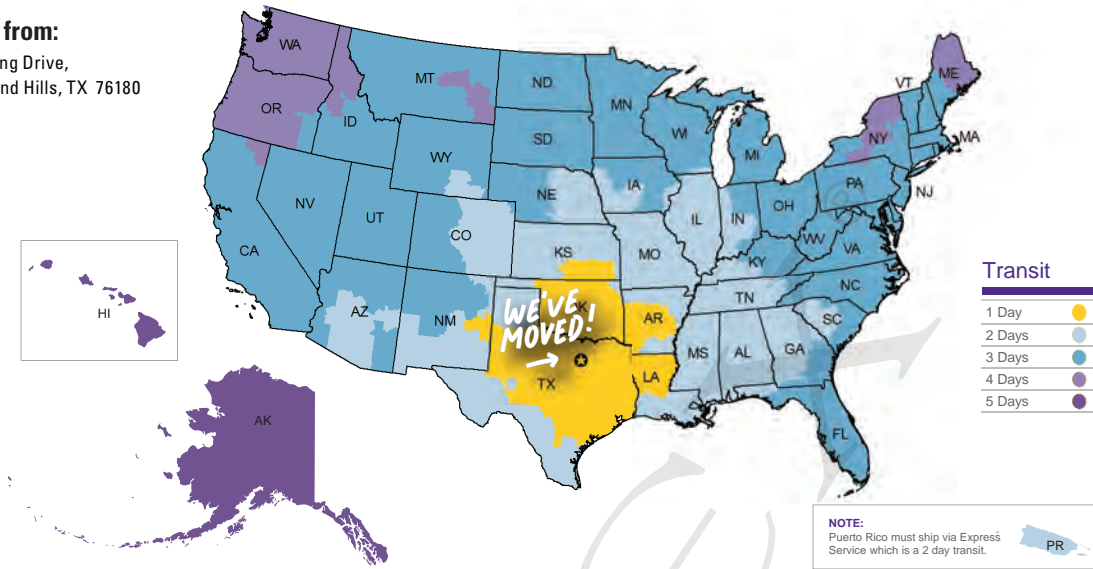

**5% Discount**  
on Prepaid Orders  
by Check or ACH Payment  
(offer excludes microscopes, colposcopes and/or extended warranties).

WE ACCEPT

**Toll Free: (888) 486-4644**  
(8:00AM-5:30PM CDT)

**Fax: (425) 895-0115**  
**E-mail: [service@gynex.com](mailto:service@gynex.com)**  
**Web: [www.gynex.com](http://www.gynex.com)**

**Terms:** Net 30 Days on open approved accounts. 1.0% finance charge per month shall apply on all past due accounts. International accounts require prepayment. New accounts may require prepayment with first order.

**Shipping:** FOB North Richland Hills, Texas. Normal shipping via UPS or FedEx Ground, and charges for shipping and handling are added to the order total. Expedited delivery (Next Day, 2nd Day, 3rd Day) available for additional charge.

**Note:** Pre-paid shipping charges of \$17.50, do not apply to Alaska, Hawaii, Puerto Rico, the Virgin Islands and other U.S. Islands, international orders or orders including colposcopes and medical exam lights. An additional custom fee may apply for the Virgin Islands and other U.S. Islands, and international orders. A handling fee will apply to orders that use customer's own shipping account.

**Partial Shipments:** We reserve the right to make partial shipments against orders and the amounts for such partial shipments will become due and payable upon receipt unless otherwise agreed to in writing by GYNEX.

**5% Discounts:** Customers may deduct an additional 5% off their total order when payment is made by check or ACH at the time of purchase. Credit card payments and COD orders do not qualify for this discount. This discount does not apply to Microscopes, Colposcopes and/or extended warranties and some specials where products are already discounted. This discount cannot be combined with other discounts.

**Warranties Returns and Disclaimers:** All information concerning these GYNEX policies are detailed on page 94 of this catalog.

**Missing Merchandise Policy:** GYNEX personnel have taken great care to pack your order. Each LOT number indicated in the first column on the Packing List corresponds with and was scanned from the product packed in this box. Quantities were verified in this manner. Back orders are clearly marked, and do not have a LOT number indicated. If anything is missing from your package, the customer is responsible for notifying GYNEX within 24 hours of the customer's receipt of package.



# GYNEX®

6631 Browning Drive, North Richland Hills, TX 76180

Tel: (888) 486-4644 • Fax: (425) 895-0115  
service@gynex.com • www.gynex.com

PRSR STD  
US POSTAGE  
**PAID**  
GYNEX



**Monsel's**  
see page 5



**Acetic Acid 5%**  
see page 5

SCAN to SHOP



**(888) 486-4644**  
**www.gynex.com**

